

Strange Particles in Nuclear Matter

- Strangeness
- Expected effects on strange particles
- The experimental tool: FOPI spectrometer
- In-medium mass modification
- $\phi(1020)$ meson: not all strange particles originate from nuclear matter
- Absorption of strange particles

Tomasz Matulewicz

Institute of Experimental Physics

Faculty of Physics, University of Warsaw

Strange Particles in Nuclear Matter

- **Strangeness**
- Expected effects on strange particles
- The experimental tool: FOPI spectrometer
- In-medium mass modification
- $\phi(1020)$ meson: not all strange particles originate from nuclear matter
- Absorption of strange particles

Tomasz Matulewicz

Institute of Experimental Physics

Faculty of Physics, University of Warsaw

6 III 2013

Sir Ernest
Rutherford
1871-1937

discovered
atomic nucleus
(1911)
Nobel 1908

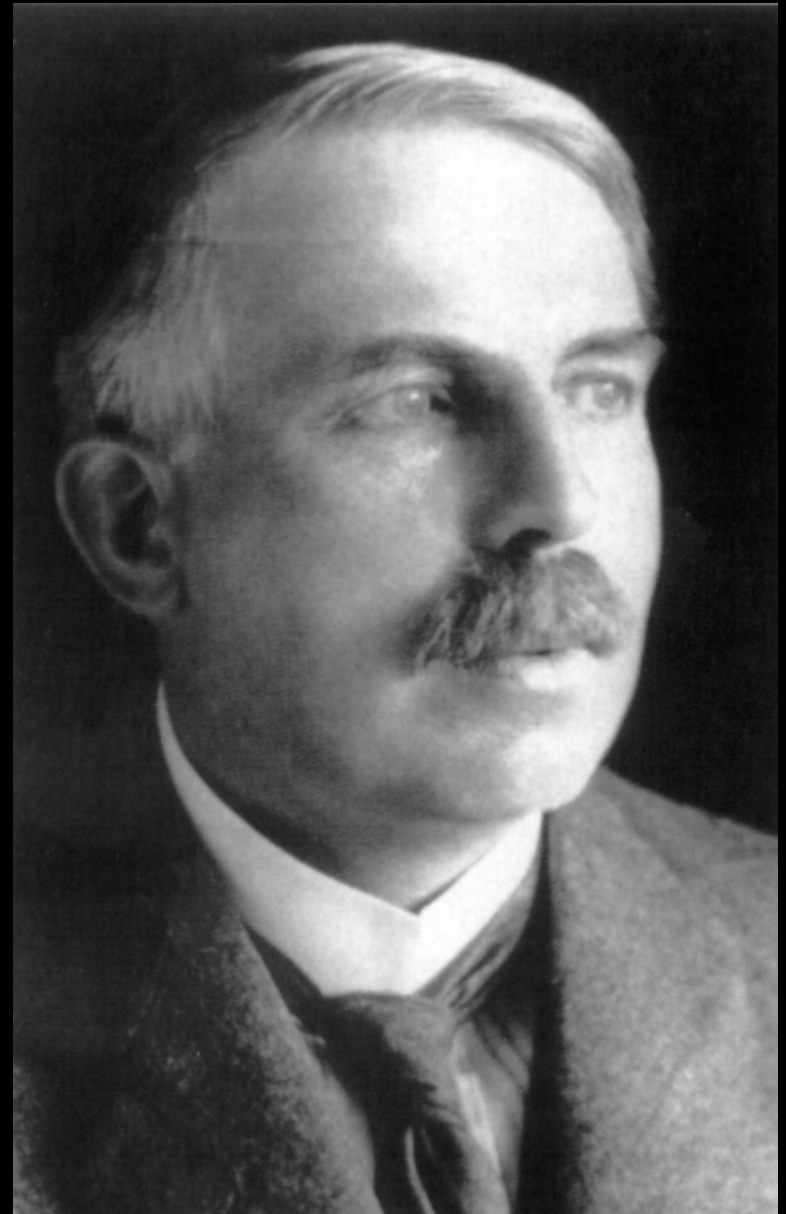

James
Chadwick
1891-1974

discovered
neutron
(1932)
Nobel 1935



Discovery of „kaon meson“ (K)

- **Rochester, Butler, 1947**

- cosmic ray particles with masses in between pions and protons which were just like pions except for strangely long lifetime
- **Always produced in pairs**

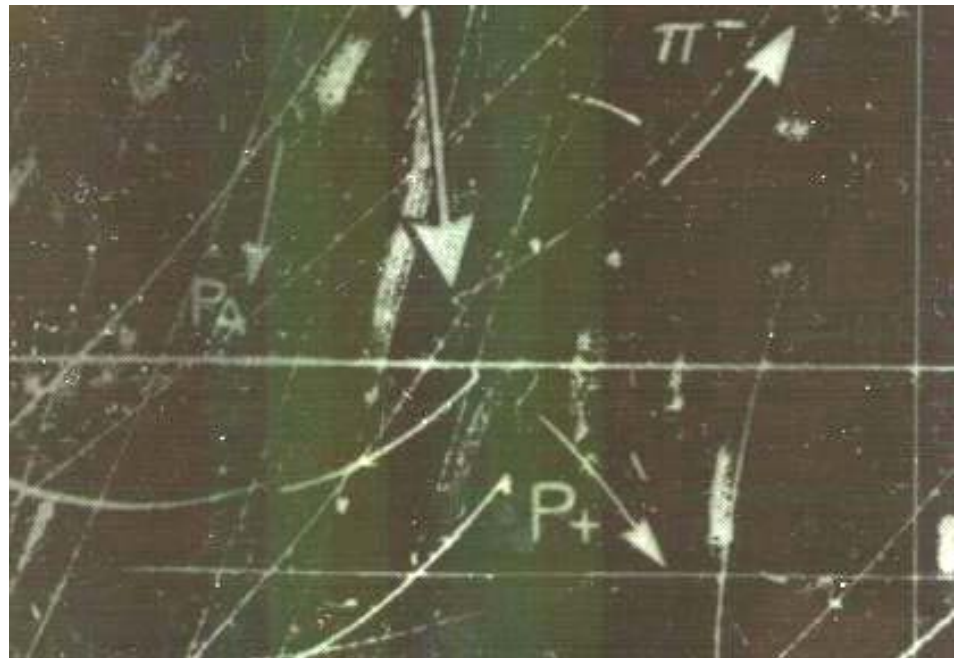

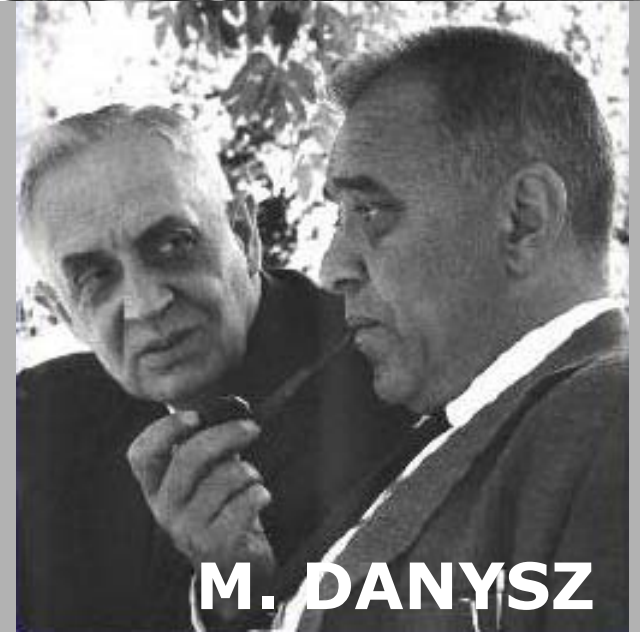
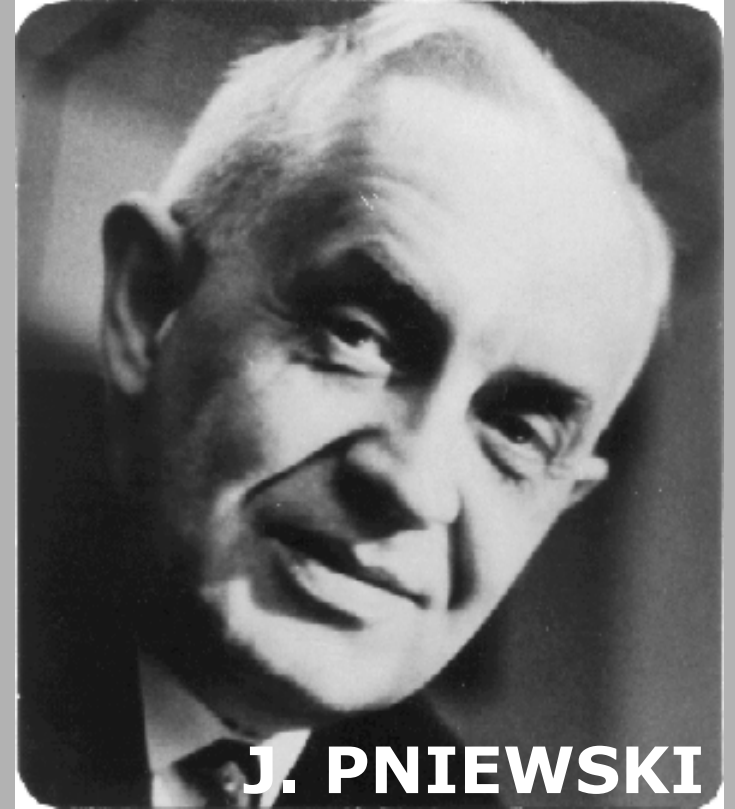
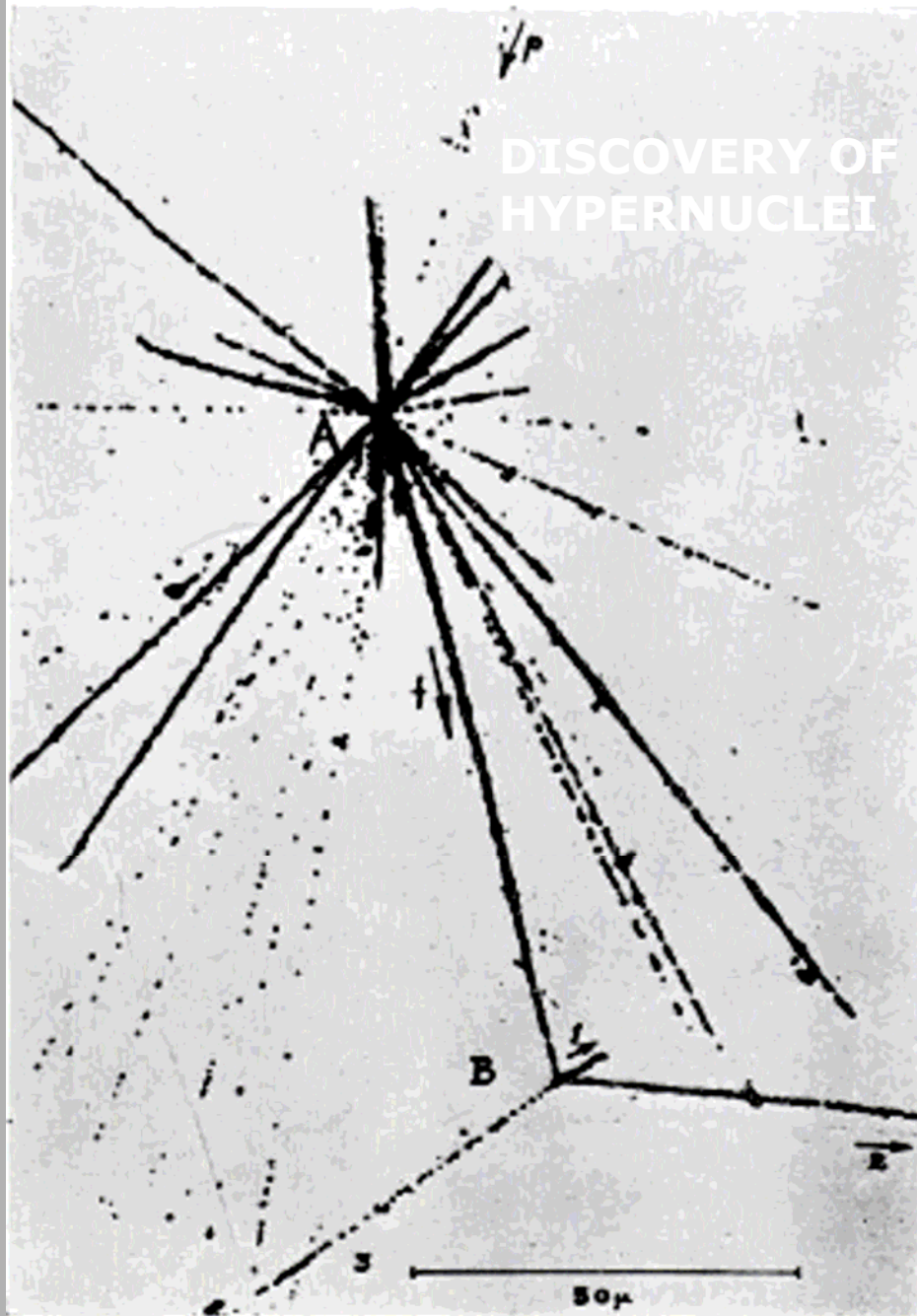

EPS historic site – Hoża 69



Hadrons: composed of quarks

Leptony	Kwarki	u górnny up	c powabny charm	t prawdziwy top
		d dolny down	s dziwny strange	b piękny bottom
		ν_e neutrino elektronowe	ν_μ neutrino mionowe	ν_τ neutrino tau
	e elektron	μ mion	τ tau	
	I	II	III	
	Rodziny materii			

- Barions: 3 quarks, or
- Mesons: quark-antiquark
- nucleons (proton or neutron) composed of u and d quarks
- Strange particles: presence of quark s

$$K^+ |u\bar{s}\rangle$$

$$\phi |s\bar{s}\rangle$$

$$K^- |\bar{u}s\rangle$$

$$\Lambda |uds\rangle$$

Strong interactions:
Conservation of quark numbers

Mesons K and ϕ

- Mesons K^+ i K^-
- Mass $\cong 494 \text{ MeV}/c^2$
- Decay $K^+ \rightarrow \mu^+ \nu_\mu$ (64%)
- $c\tau \approx 3,7 \text{ m}$

- Meson ϕ
- Mass $\cong 1020 \text{ MeV}/c^2$
- Decay $\phi \rightarrow K^+ K^-$ (49%)
- $c\tau \approx 47 \text{ fm}$ ($47 \cdot 10^{-15} \text{ m}$)

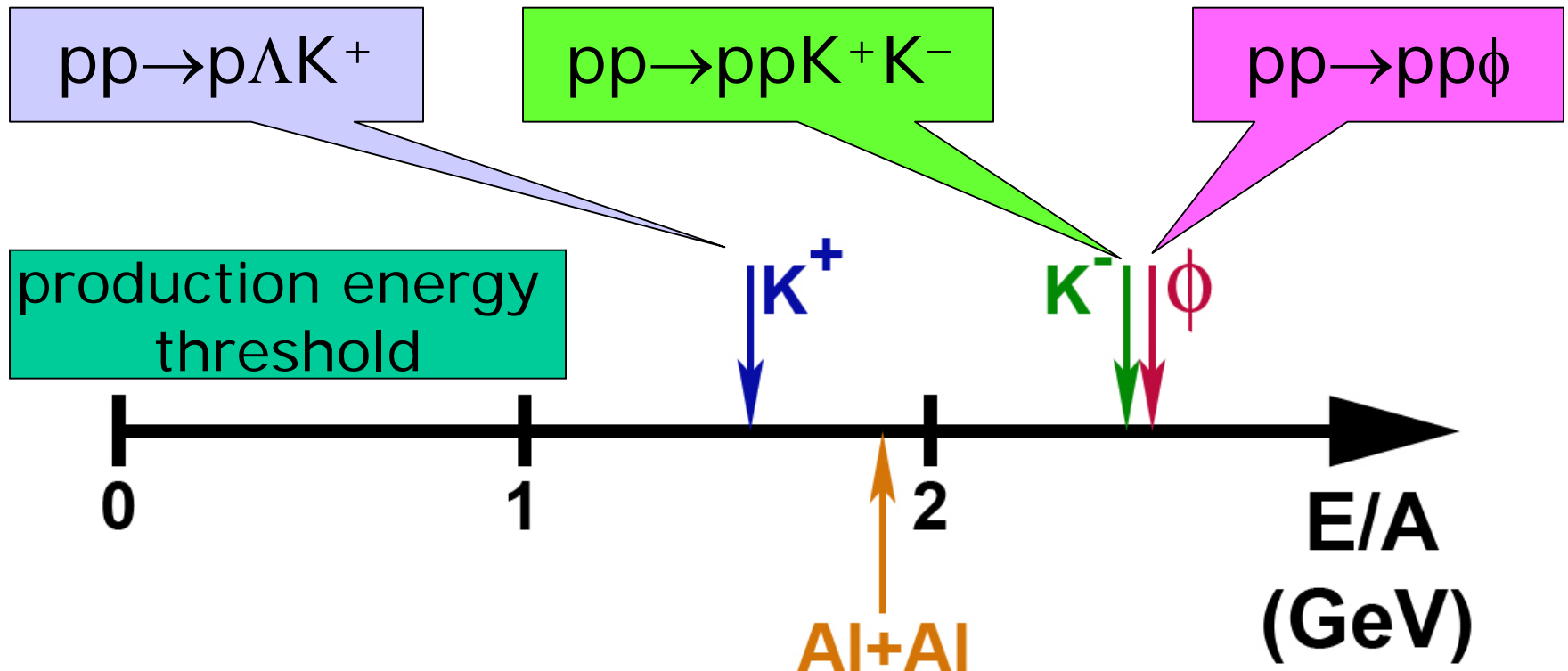

Strange Particles in Nuclear Matter

- Strangeness
- **Expected effects on strange particles**
- The experimental tool: FOPI spectrometer
- In-medium mass modification
- $\phi(1020)$ meson: not all strange particles originate from nuclear matter
- Absorption of strange particles

Tomasz Matulewicz

Institute of Experimental Physics

Faculty of Physics, University of Warsaw

6 III 2013

Mesons K and ϕ

- Mesons K^+ i K^-
- Mass $\cong 494 \text{ MeV}/c^2$
- Decay $K^+ \rightarrow \mu^+ \nu_\mu$ (64%)
- $c\tau \approx 3,7 \text{ m}$

- Meson ϕ
- Mass $\cong 1020 \text{ MeV}/c^2$
- Decay $\phi \rightarrow K^+ K^-$ (49%)
- $c\tau \approx 47 \text{ fm}$ ($47 \cdot 10^{-15} \text{ m}$)

Mean free path in nuclear matter

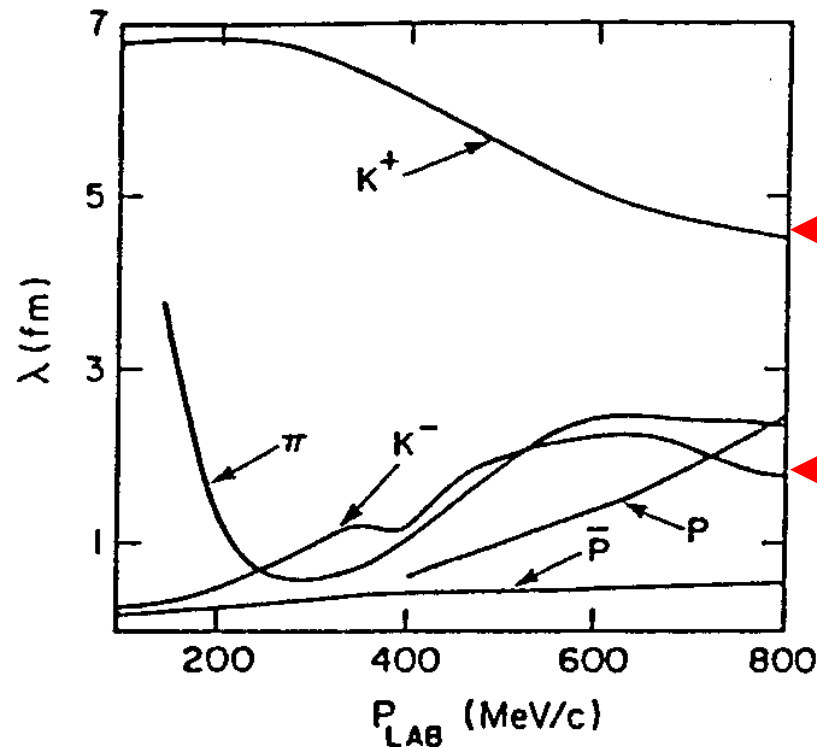

$$K^+ |u\bar{s}\rangle$$

$$K^- |\bar{u}s\rangle$$

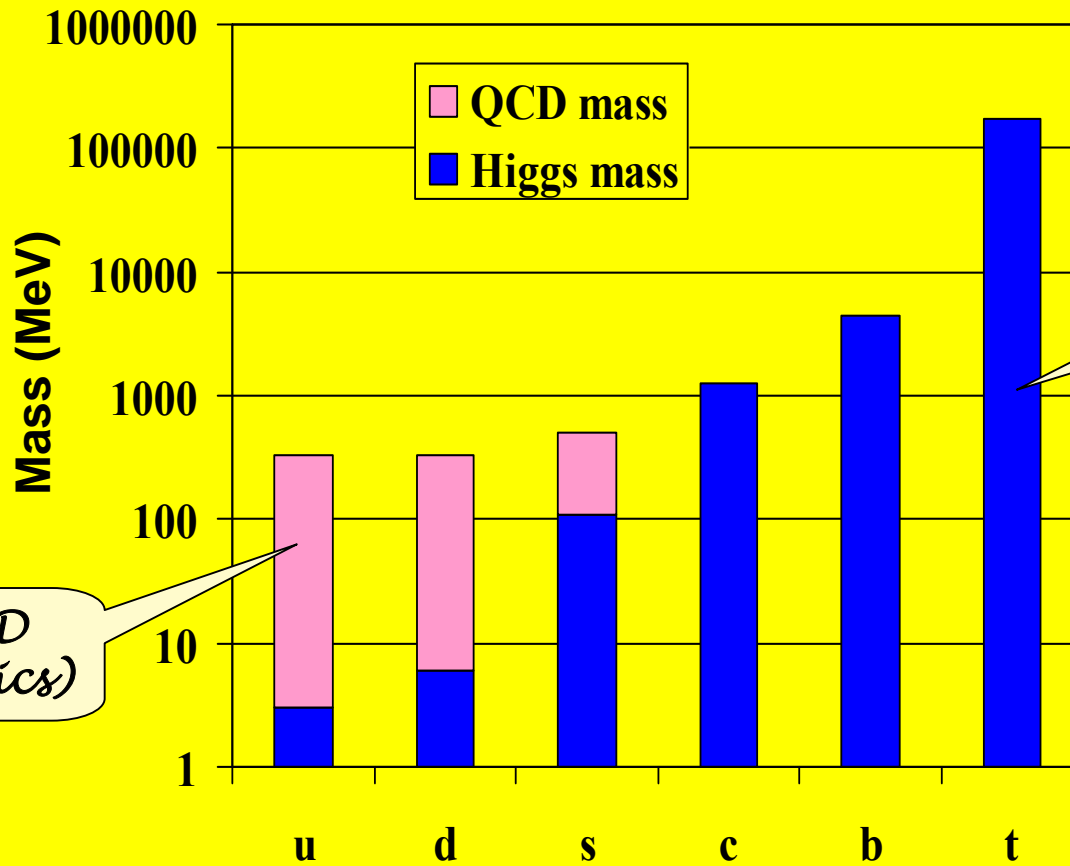

NP (QCD dynamics)

HEP (Higgs)

$$u + u + d = \text{proton}$$

mass: $0.003 + 0.003 + 0.006 \neq 0.938 \text{ GeV}$

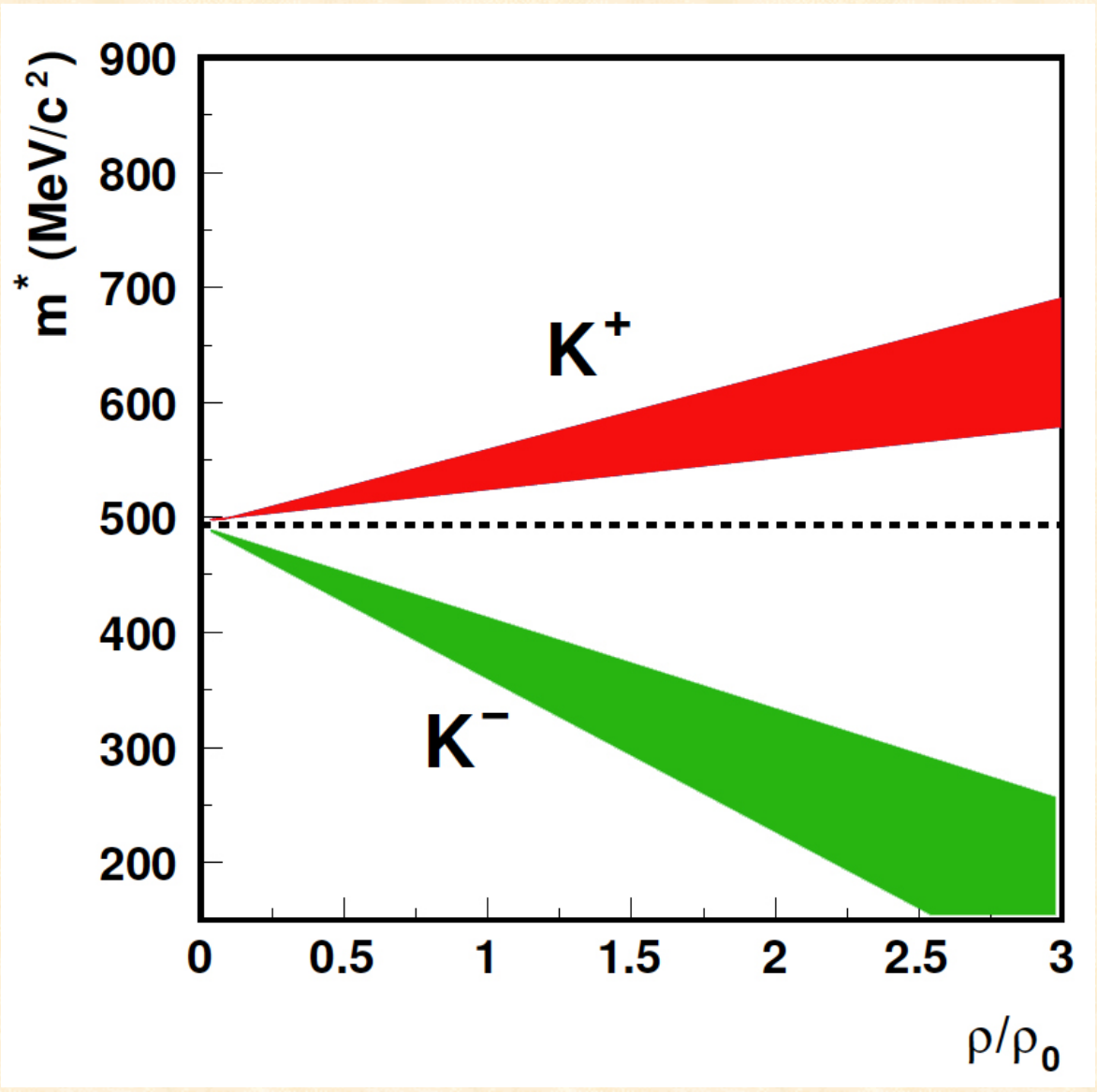

THEORY
KN potential:

repulsive for
 K^+

and

attractive for
 K^-

Structure of matter

matter



(macroscopic)

crystal

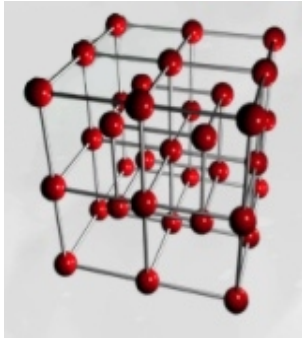

10^{-9} m

atom

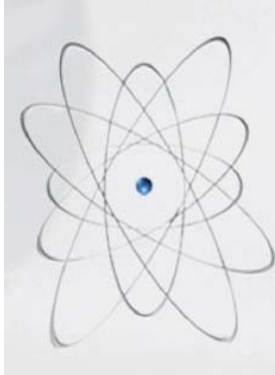

10^{-10} m

nucleus



10^{-14} m

nucleon

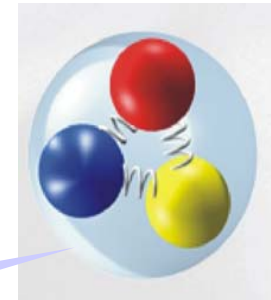

10^{-15} m

quark

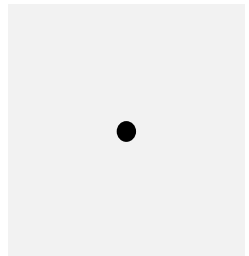

$< 10^{-18}$ m

$$m_u \sim m_d \sim 2-6 \text{ MeV}/c^2$$
$$m_N \sim 940 \text{ MeV}/c^2$$

What's inside the neutron star?

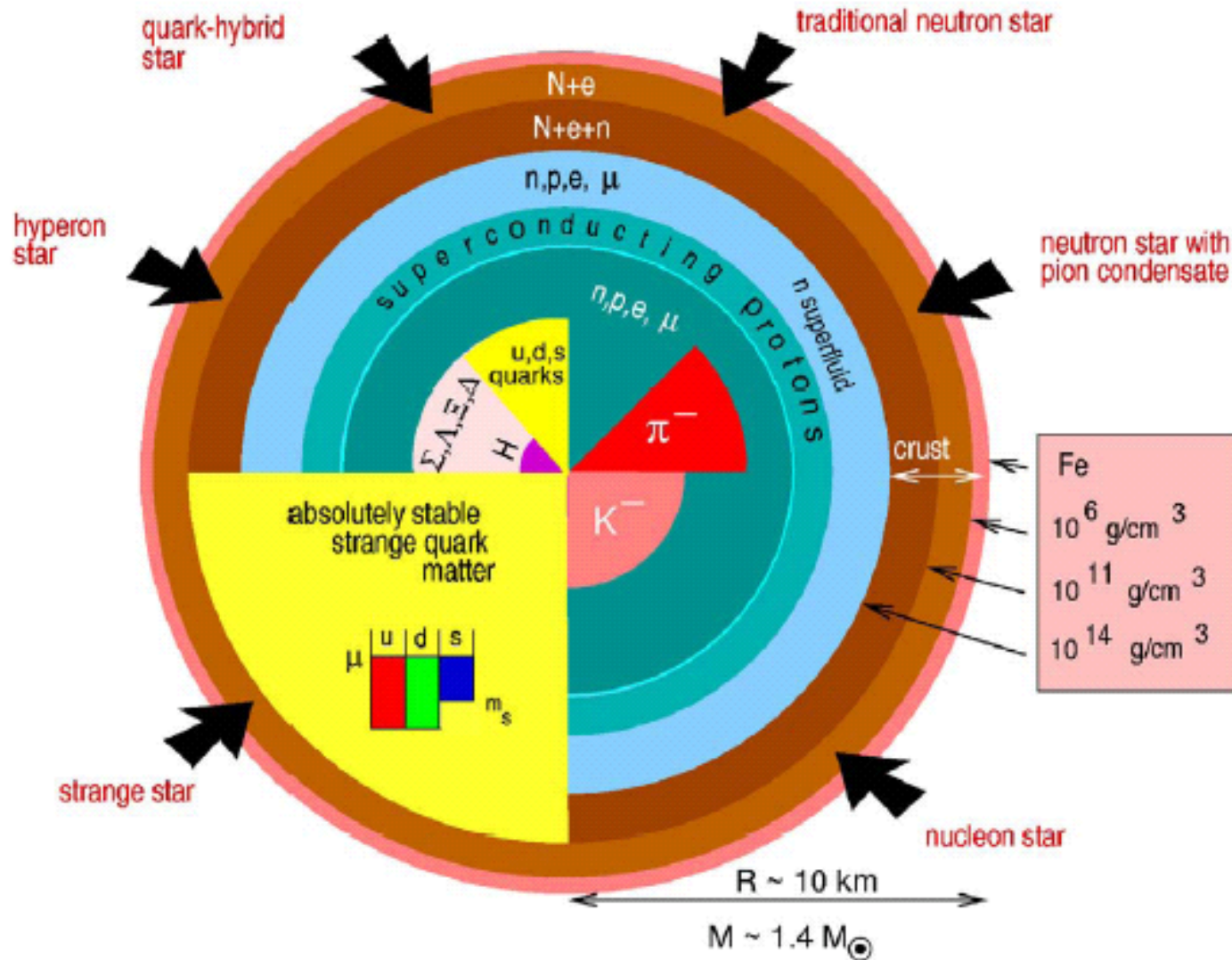

Simulation of Au+Au collision

First-chance collisions

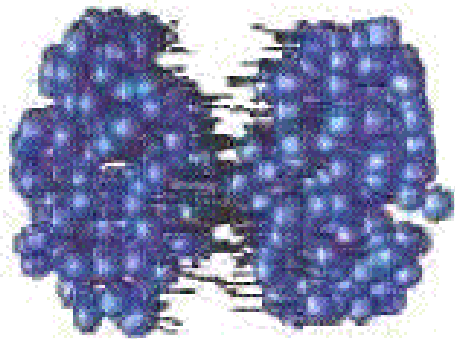

Dense matter

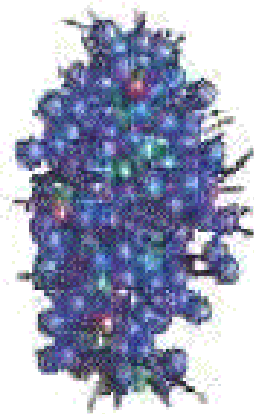

Freeze-out

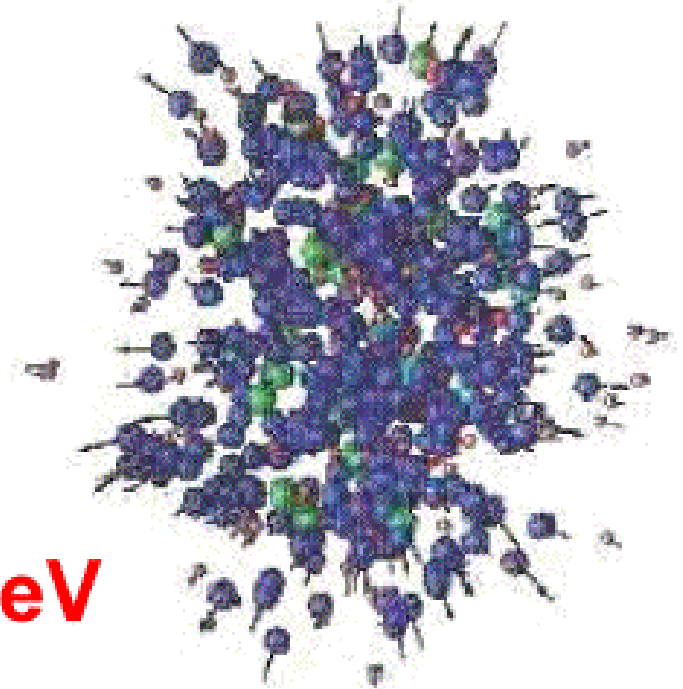

- nucleons
- resonances
- mesons

Au+Au 1 AGeV

URQMD transport model

J. Phys. G: Nucl. Part. Phys. **25**(1999)1859

Au+Au 1,5A GeV

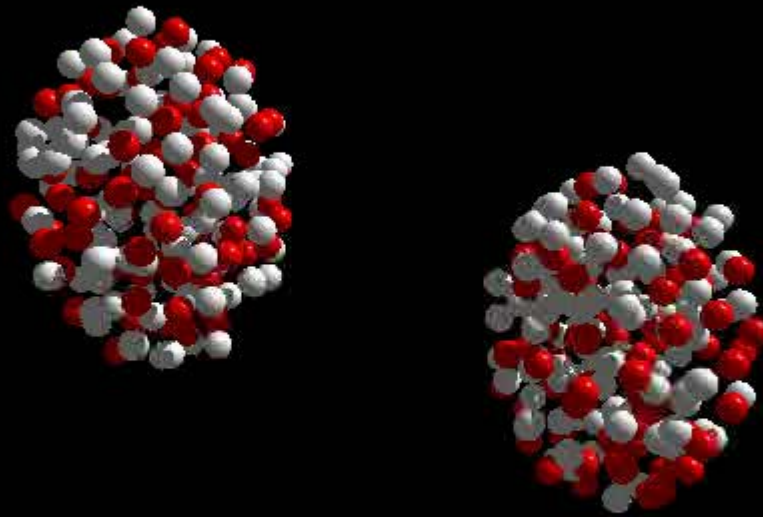

cross section for K-meson production

Comparison of proton-proton and nucleus-nucleus

"Subthreshold" production: qualitative explanation through the Fermi motion

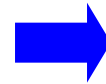
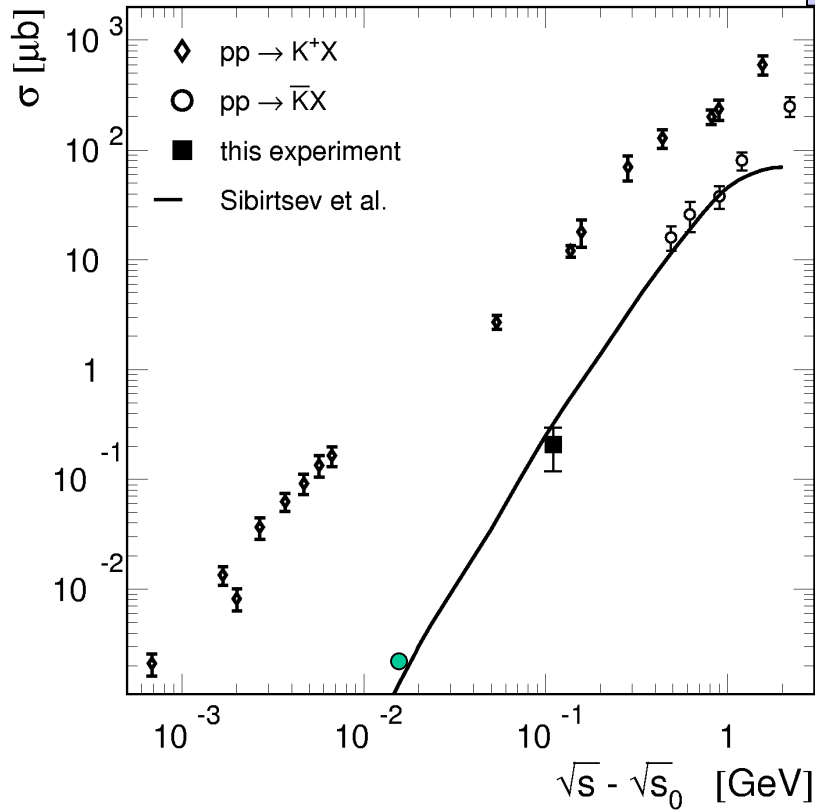

Strong rise of the production of K-mesons

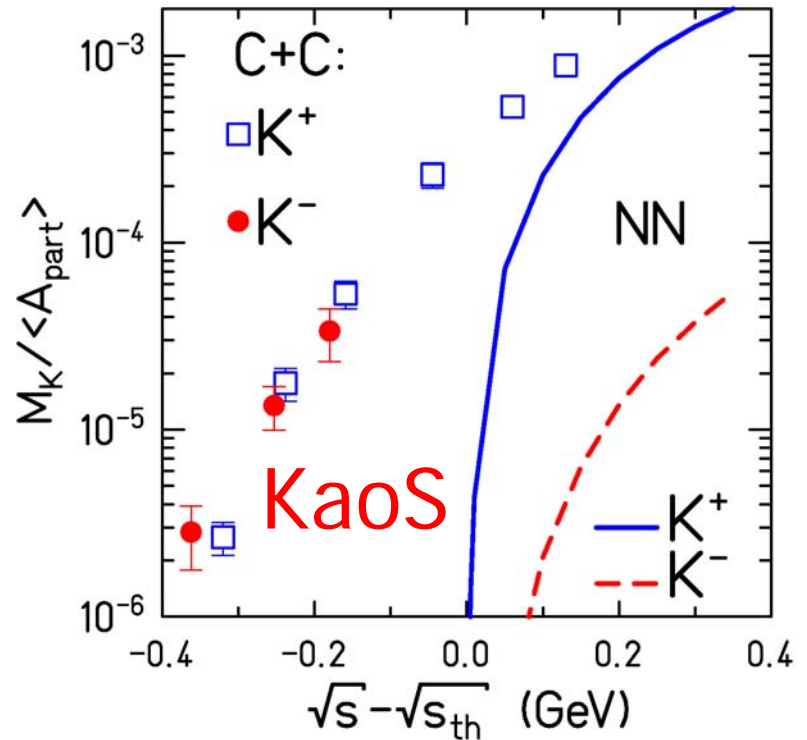

Strange Particles in Nuclear Matter

- Strangeness
- Expected effects on strange particles
- **The experimental tool: FOPI spectrometer**
- In-medium mass modification
- $\phi(1020)$ meson: not all strange particles originate from nuclear matter
- Absorption of strange particles

Tomasz Matulewicz

Institute of Experimental Physics

Faculty of Physics, University of Warsaw

6 III 2013

FOPi spectrometer at GSI Darmstadt

- Covers almost full solid angle (FOur PI)
- Magnetic field $B=0,6\text{ T}$
- 2 types of detectors: drift chambers (dE/dx , p_t) and scintillation (ToF)
- Directly measured: p , d , t , ${}^3\text{He}$, π^\pm , K^\pm

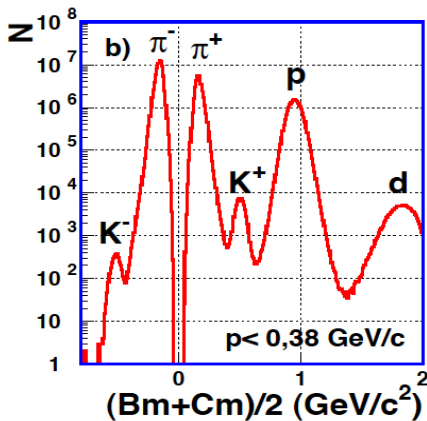
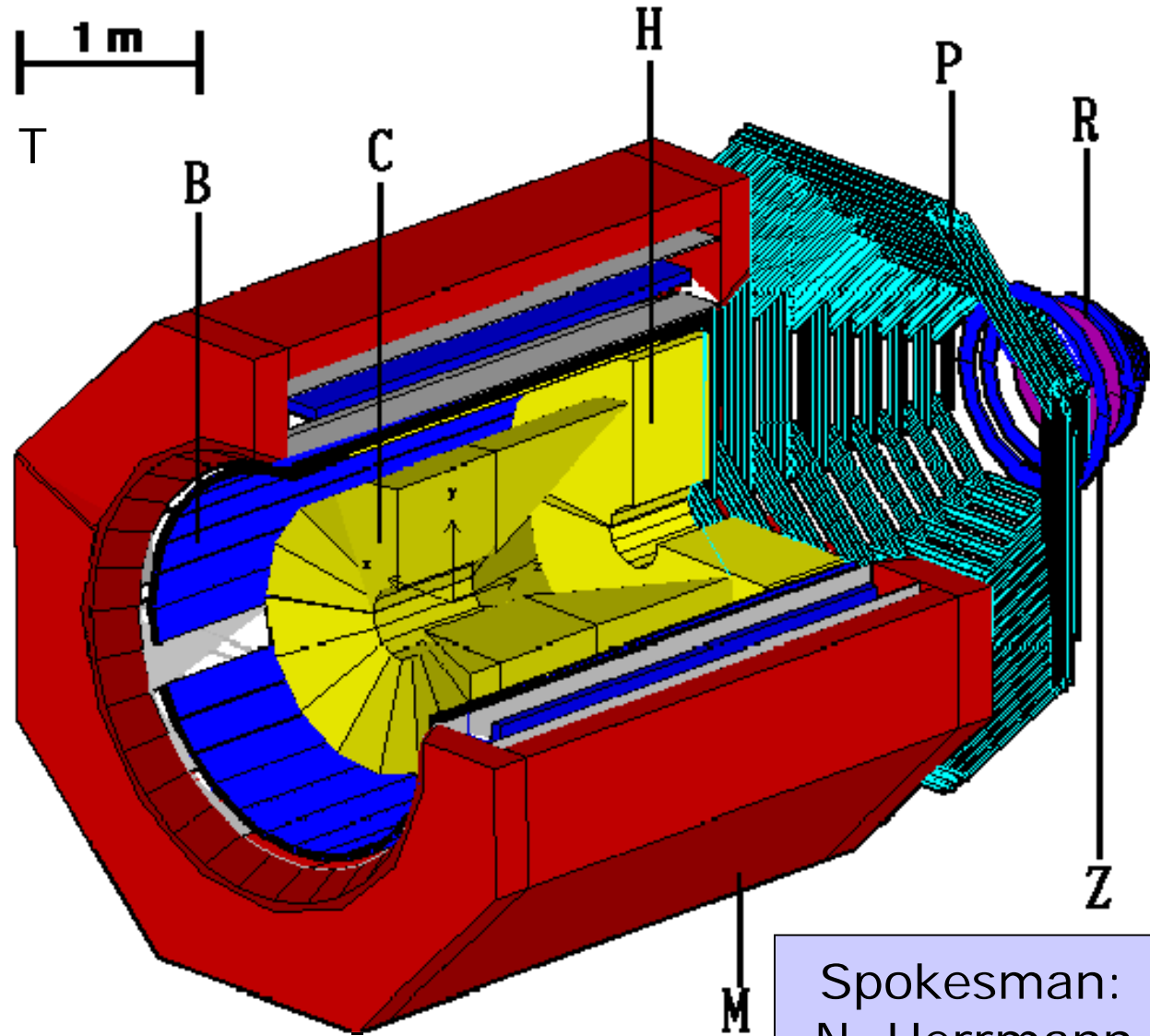

Spokesman:
 N. Herrmann
 U. Heidelberg

x-y plane
Run 3013
Event 7538

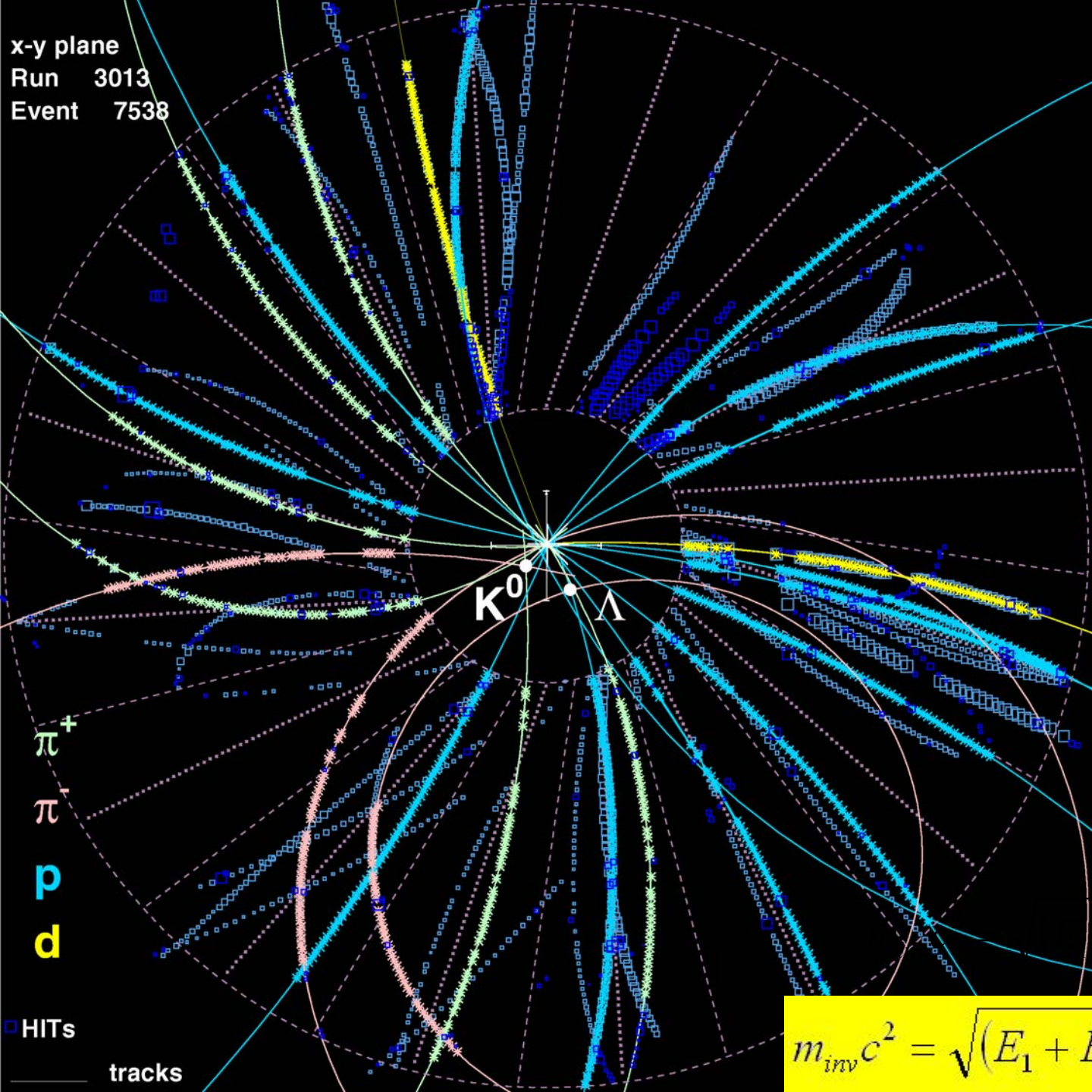

Invariant mass analysis of pairs of particles allows to identify short-lived neutral particles: Λ , K^0 , ϕ

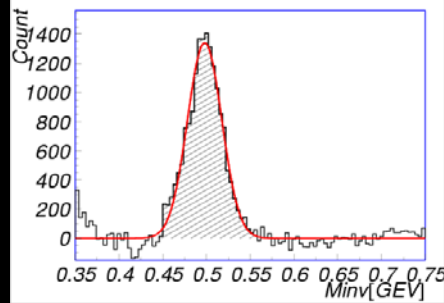
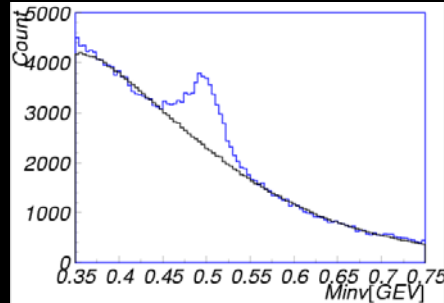

π^+
 π^-
p
d

HITs
tracks

$$m_{inv} c^2 = \sqrt{(E_1 + E_2)^2 - (\vec{p}_1 + \vec{p}_2)^2} c^2$$



Strange Particles in Nuclear Matter

- Strangeness
- Expected effects on strange particles
- The experimental tool: FOPI spectrometer
- **In-medium mass modification**
- $\phi(1020)$ meson: not all strange particles originate from nuclear matter
- Absorption of strange particles

Tomasz Matulewicz

Institute of Experimental Physics

Faculty of Physics, University of Warsaw

6 III 2013

Identification of K mesons

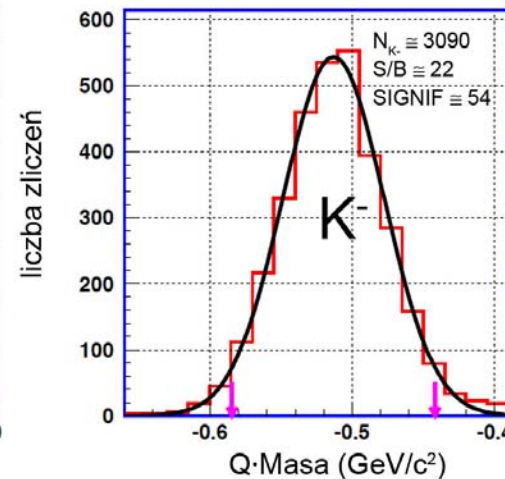
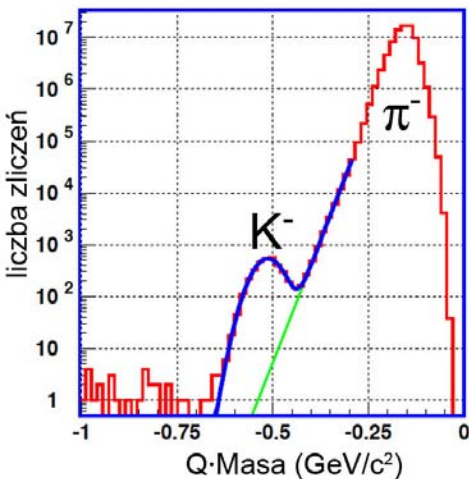
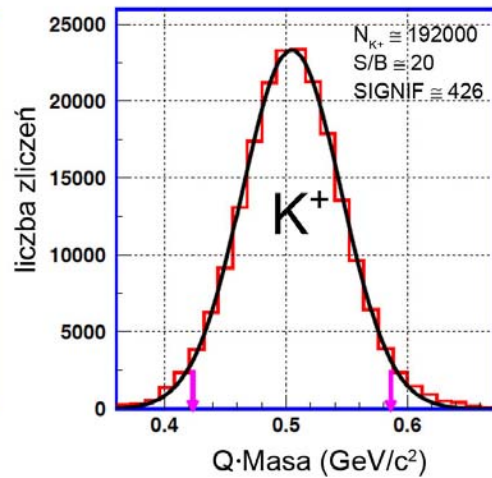
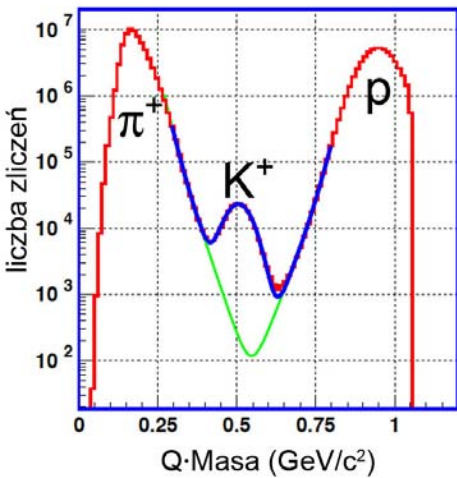

- Al+Al, E=1,9A GeV
- 192500 K⁺ mesons
- 3090 K⁻ mesons
- The simulation of the response function of the spectrometer allows to correct for the efficiency and get the emission probability per collision:
 - K⁺: 3,73%
 - K⁻: 0,11%
- Relative errors:
 - K⁺: ±15% (syst!)
 - K⁻: ±30% (stat!)

Ratio of K^-/K^+ emission

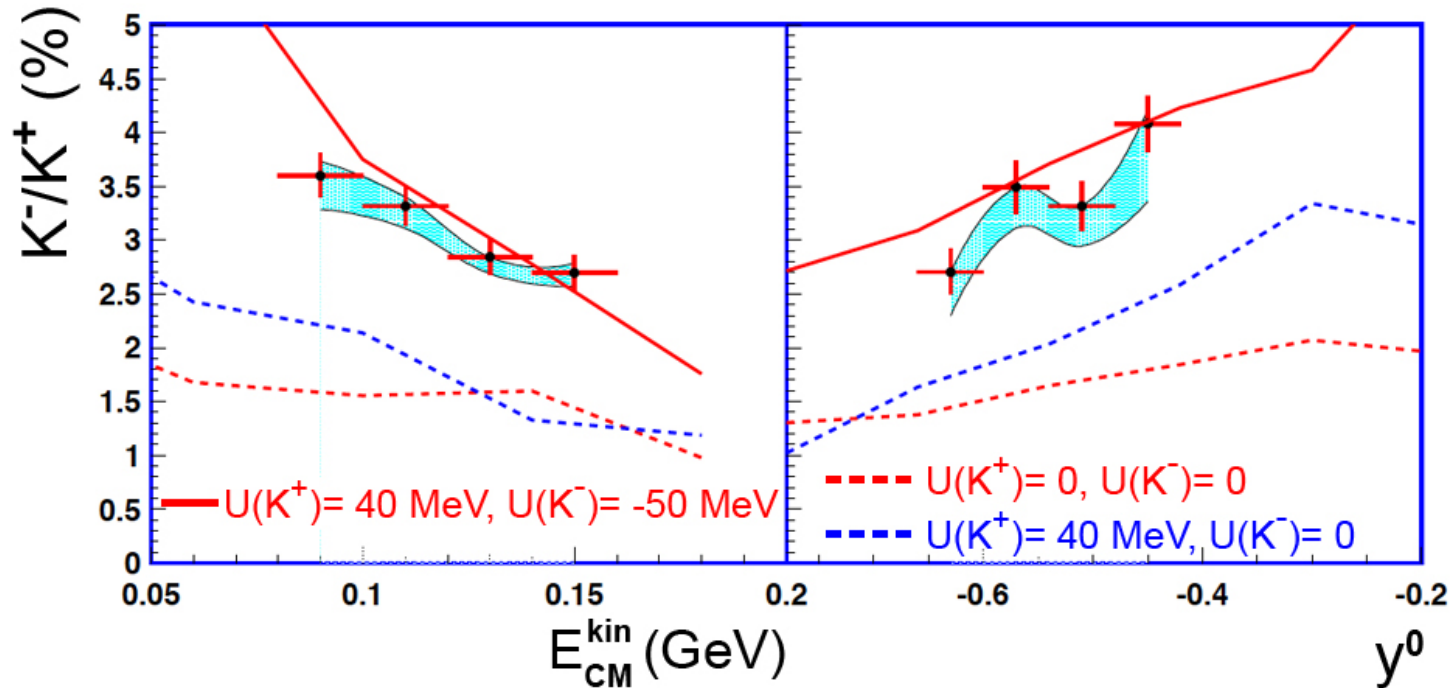

- Without additional potentials (change of the effective mass of K mesons) the data are not described: $U(K^-) = -50$ MeV, $U(K^+) = 40$ MeV
- K^- are attracted, while K^+ repulsed: the rise of K^-/K^+ ratio for low kinetic energies

Strange Particles in Nuclear Matter

- Strangeness
- Expected effects on strange particles
- The experimental tool: FOPI spectrometer
- In-medium mass modification
- $\phi(1020)$ meson: not all strange particles originate from nuclear matter
- Absorption of strange particles

Tomasz Matulewicz

Institute of Experimental Physics

Faculty of Physics, University of Warsaw

6 III 2013

IQMD calculations
Au+Au, $E_{LAB} = 2A$ GeV

$\beta_{cm} = 0,72$

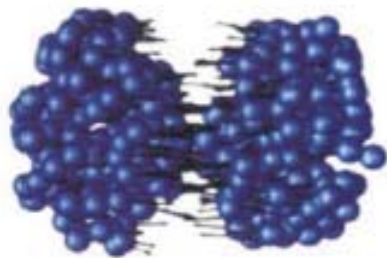

K⁻



$\rho = (2,5 - 3)\rho_0$

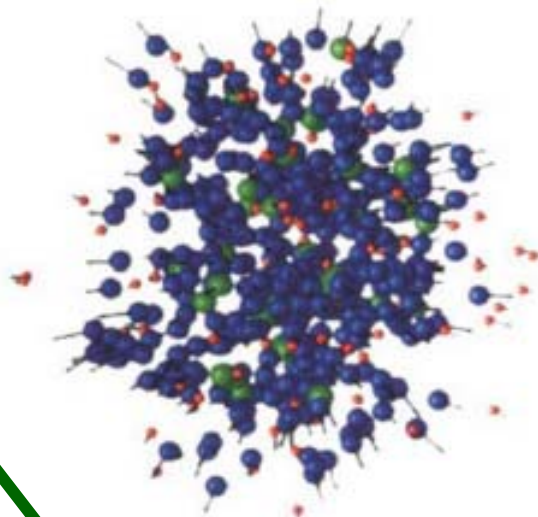
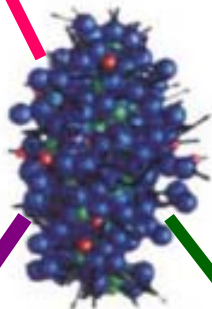

0 10 20 30 t (fm/c)

K⁻



ϕ

K⁺



Emitted from high-density nuclear matter

49.6%

K⁺

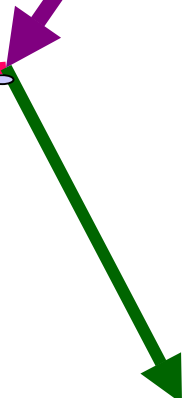

Emitted (principally) in vacuum

IQMD calculations
Au+Au, $L_{AB} = 2A$ GeV

$\beta_{cm} = 0,72$

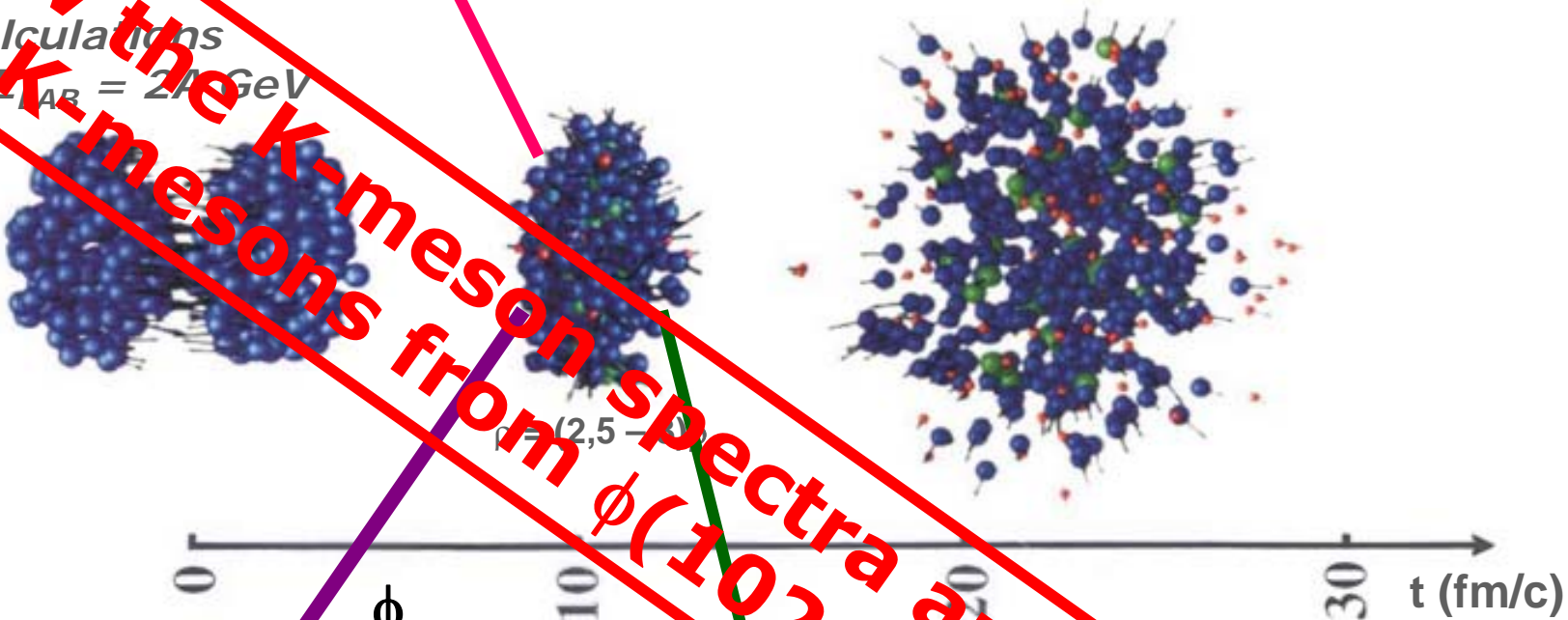

How the K-meson spectra are influenced by K-mesons from $\phi(1020) \rightarrow K^+K^-$ decay?

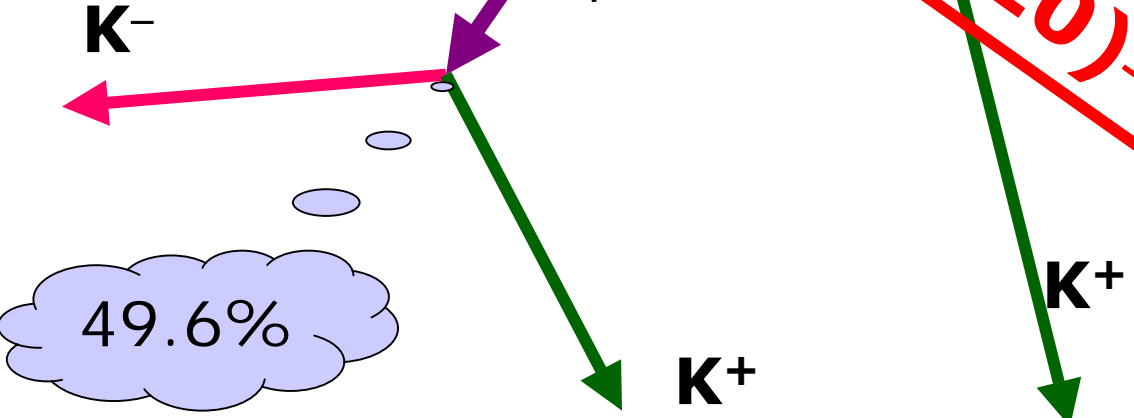

49.6%

Identification of ϕ -meson through decay $\phi \rightarrow K^+K^-$

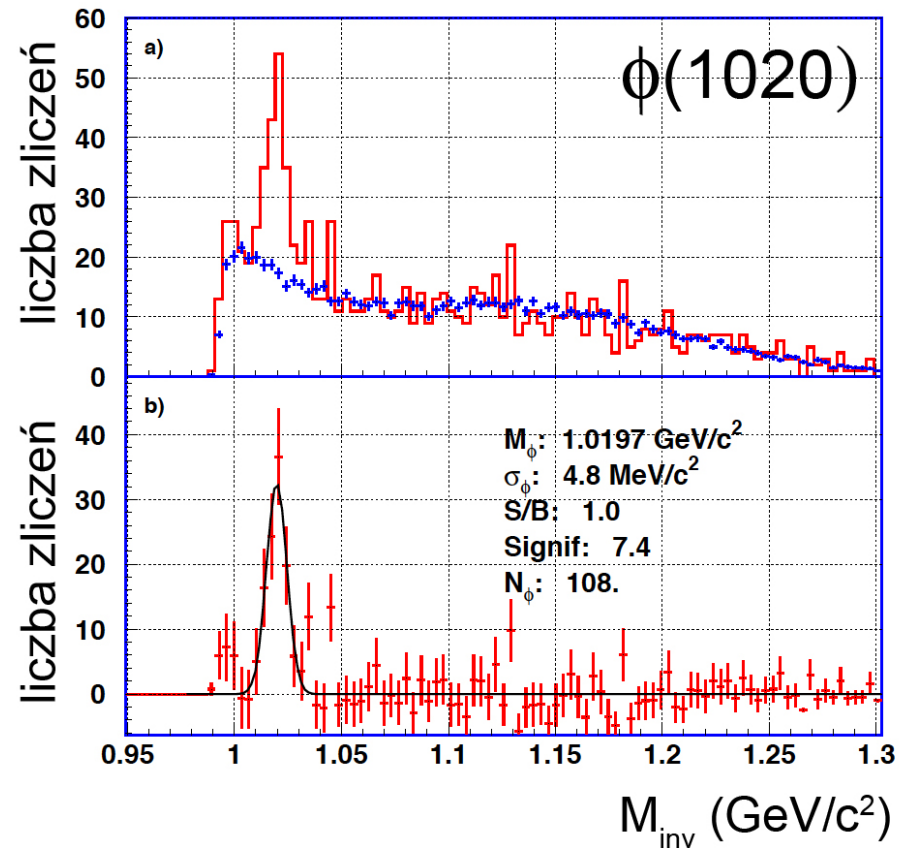
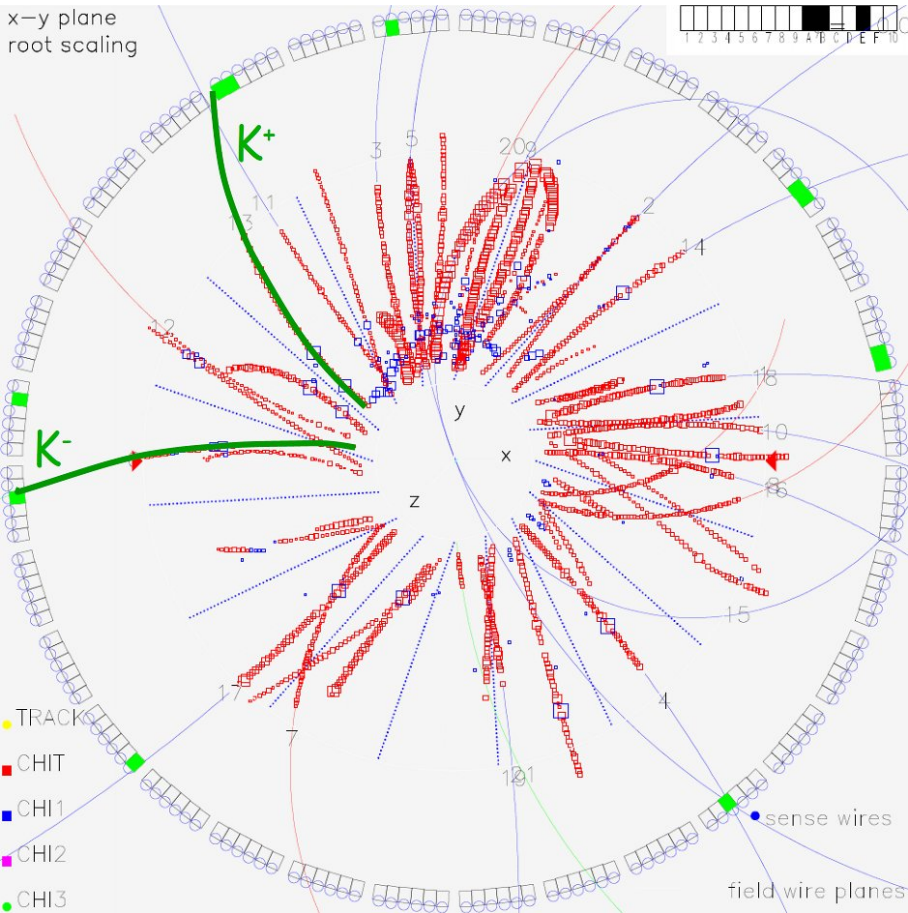

- Analysis of the invariant mass spectrum of K^+K^- pairs allowed to determine the number of ϕ : 108

collision
Al+Al
1,9A GeV

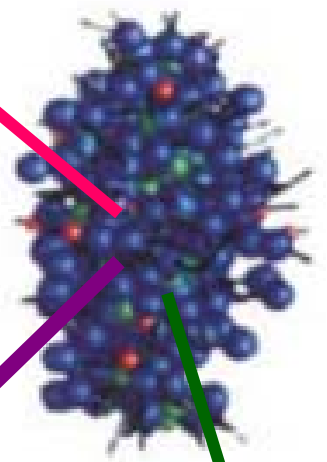

$$\rho = (2,5 - 3)\rho_0$$

**14 \pm 4 $^{+2}_{-1}$ %
K⁻ emission**

K⁻

K⁻

ϕ

K⁺

Emitted from high-density nuclear matter

Emitted (principally) in vacuum

K⁺

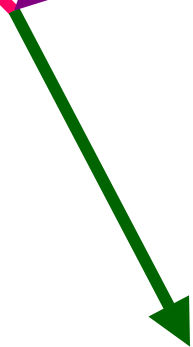

From raw data to the result

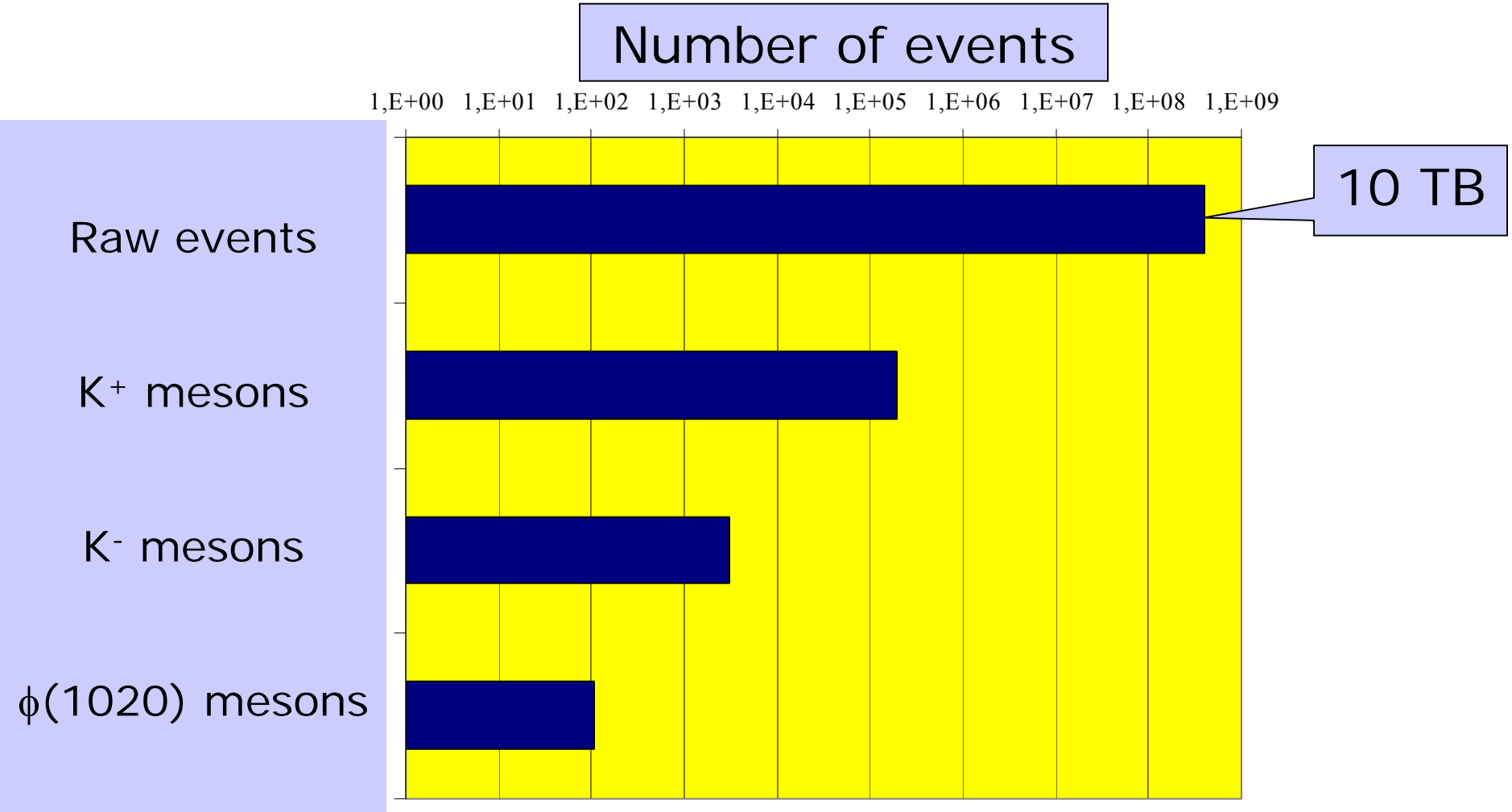

Strange Particles in Nuclear Matter

- Strangeness
- Expected effects on strange particles
- The experimental tool: FOPI spectrometer
- In-medium mass modification
- $\phi(1020)$ meson: not all strange particles originate from nuclear matter
- **Absorption of strange particles**

Tomasz Matulewicz

Institute of Experimental Physics

Faculty of Physics, University of Warsaw

6 III 2013

Investigation of the $\pi^-p \rightarrow \Lambda K^0$ process in nuclear matter

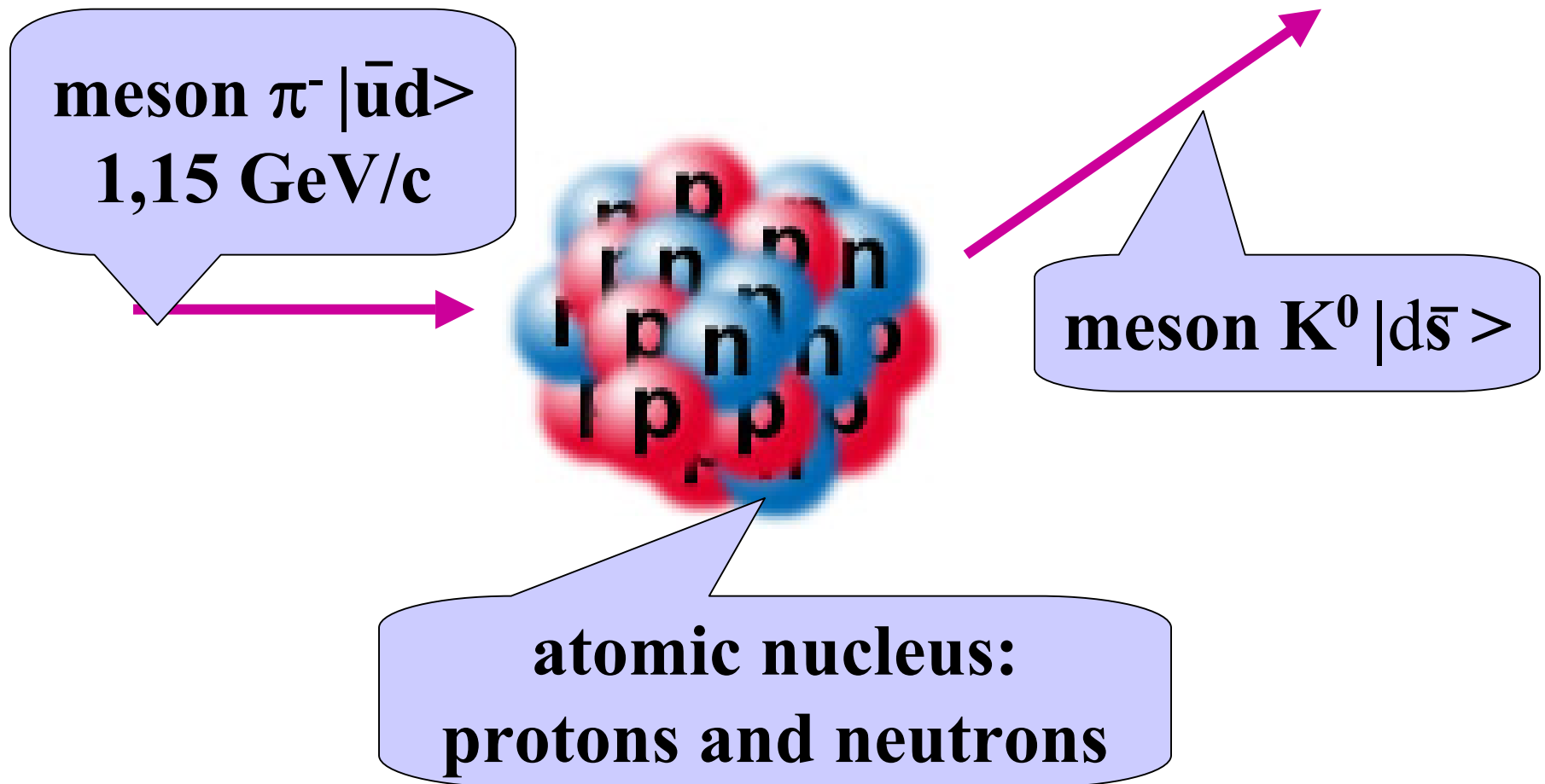

the nuclear matter influences the cross section

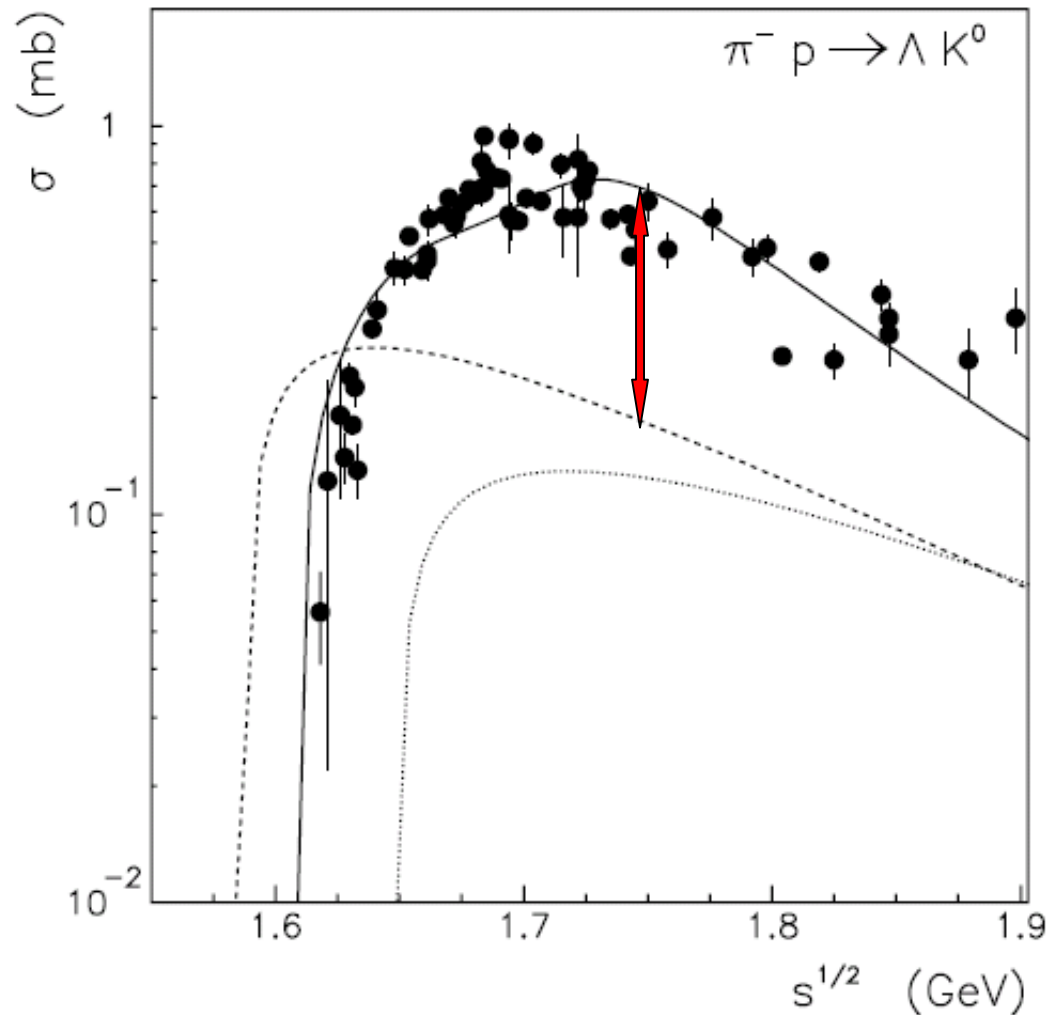

THEORY:

The cross section for the $\pi^- p \rightarrow \Lambda K^0$ reaction depends on the density of nuclear matter

Figure 1: Momentum dependence of the cross section of the $\pi^- p \rightarrow \Lambda K^0$ reaction; points – data, lines – calculation in free space (solid), at the normal baryon density (dashed), and at twice the normal baryon density (dotted).

the nuclear matter influences the cross section

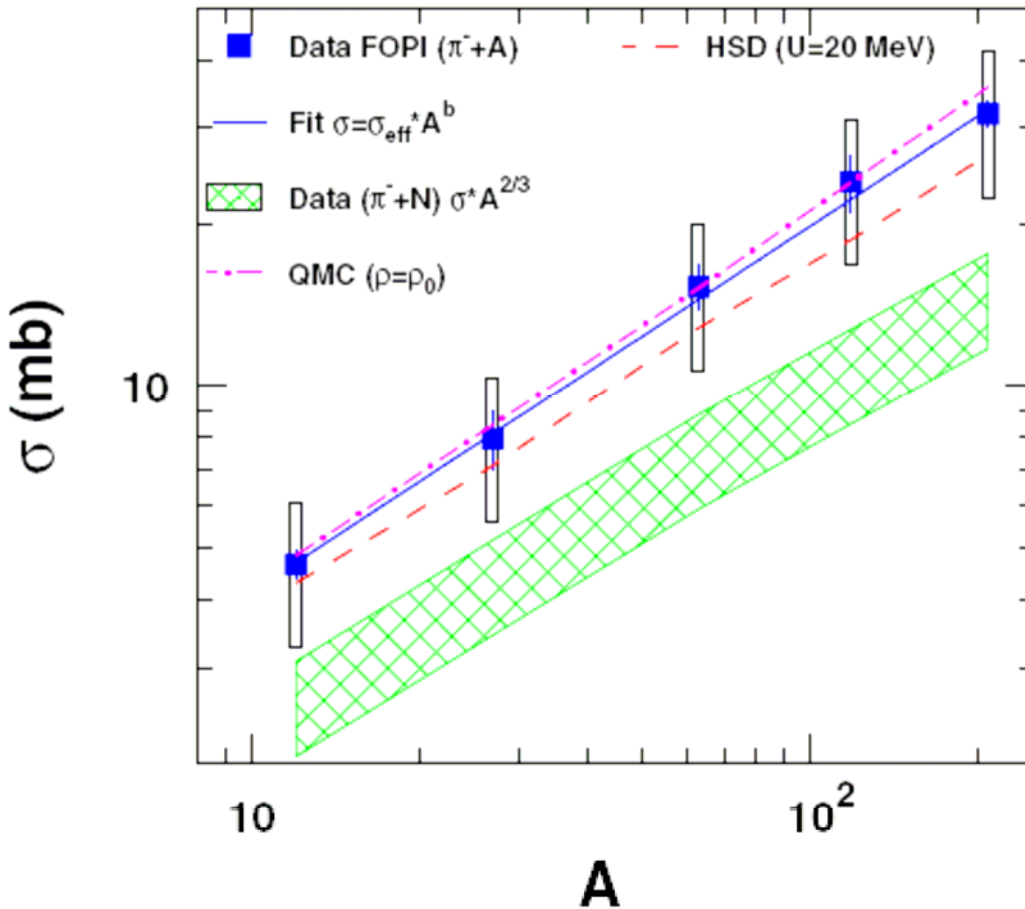

FIG. 2 (color online). The K^0 inclusive production cross section (squares) as a function of the mass number of the target nucleus. The solid line represents the fit with a power law function. The hatched area corresponds to the sum of the cross sections of the elementary processes scaled according to the transverse size of the target nuclei. QMC model predictions at $\rho = \rho_0$ [6] (dashed-dotted line) are scaled with the same prescription, whereas HSD transport-model calculations (dashed line) yield absolute predictions.

The result of the measurement confirms the strong modification of cross section

Idea of the experiment



Secondary beam of π^-

12
C

208
Pb

K^0 mesons are measured via their decay:
 $K^0 \rightarrow \pi^- \pi^+$



Ratio of the experimental angular distributions eliminates the apparatus effects and is sensitive only to the ratio of the nuclear radius and the absorption length of K meson.

Ratio of angular distributions

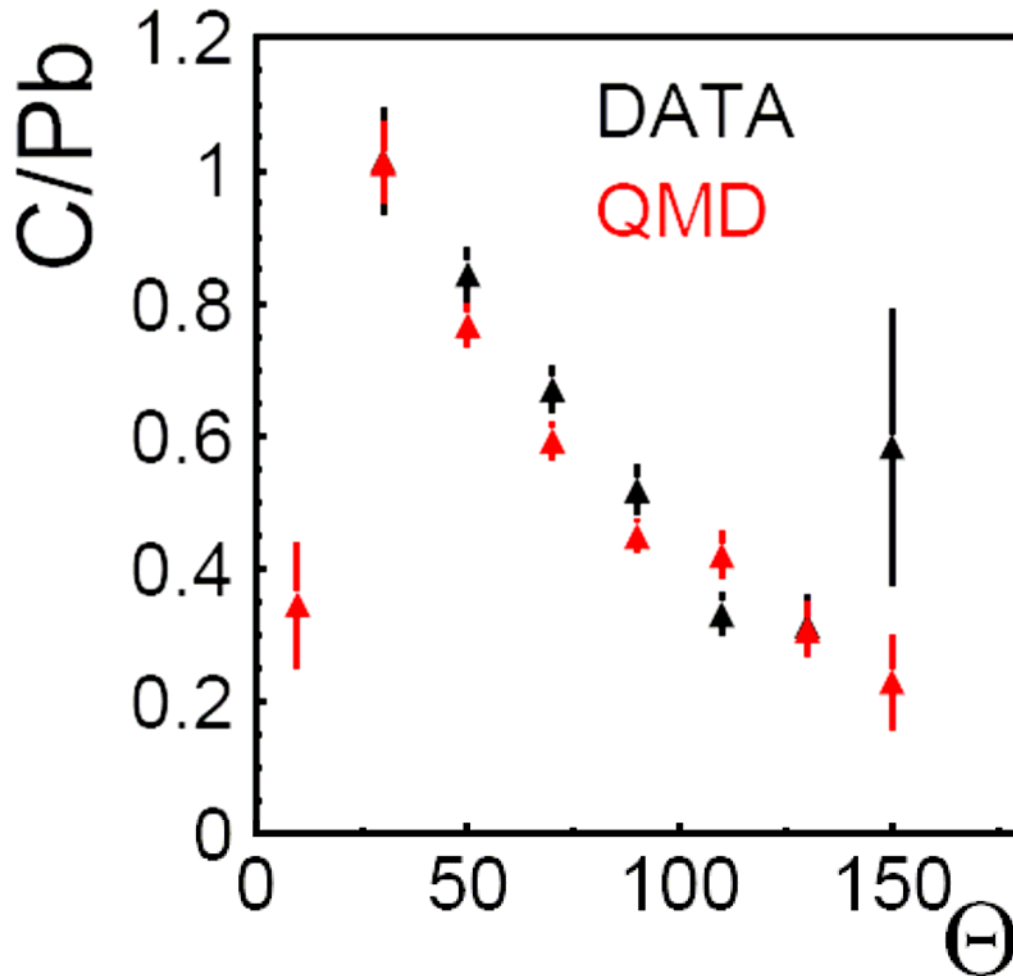

Ratio of angular distributions for C and Pb targets, normalized at $\theta=30^\circ$.

Intense emission of K^0 mesons at low angles for light target (C) compared to heavy target (Pb): reabsorption of mesons in nuclear matter.

$$\lambda_K = 4 \dots 5 \text{ fm}$$

Red points: results of the quantum dynamical model IQMD filtered with the detector acceptance

conclusions

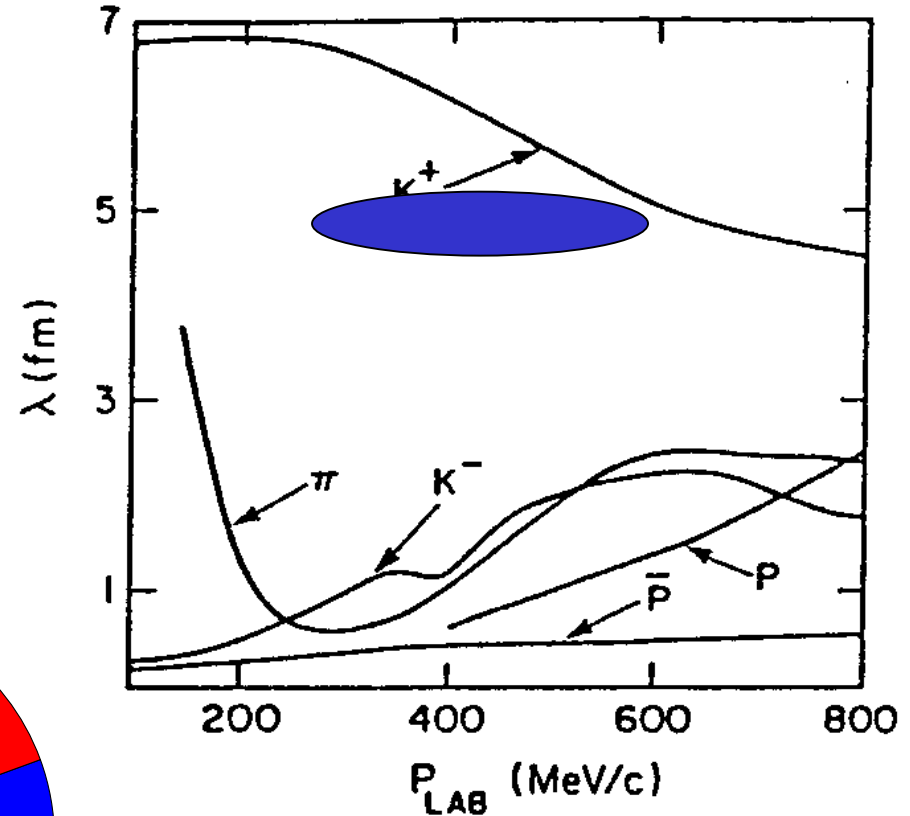
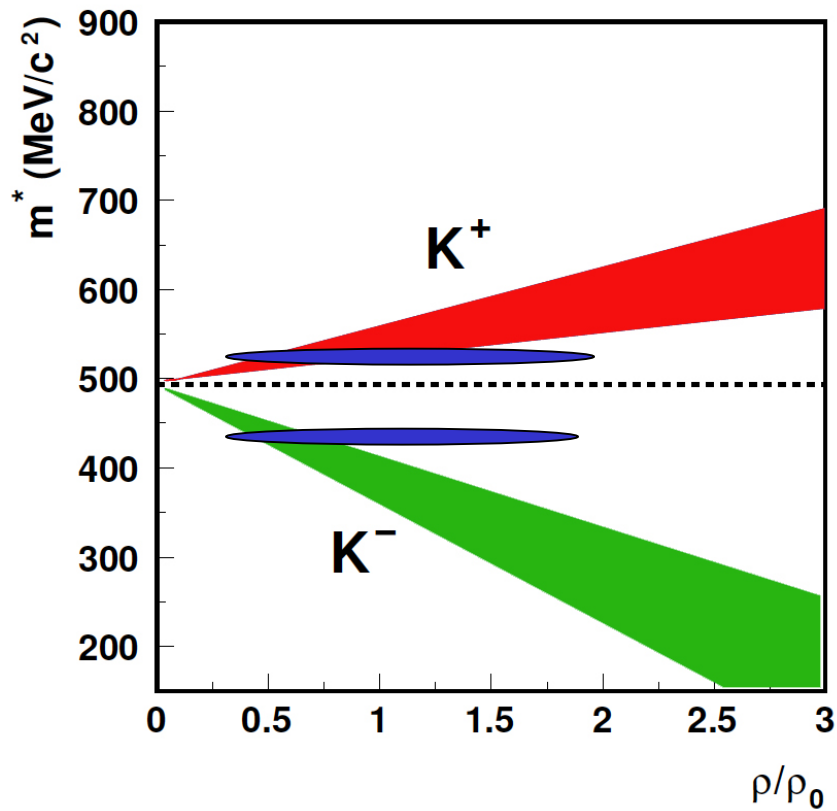

K^- from nuclear matter

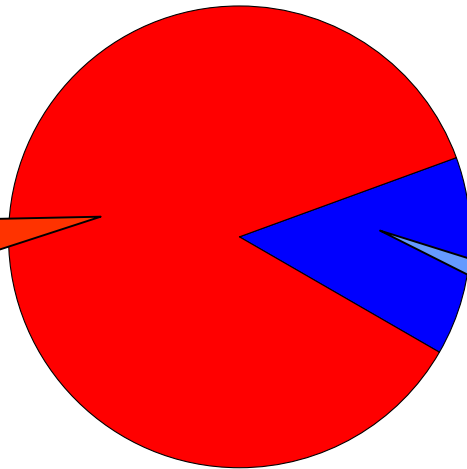

K^- from decay of ϕ



experimental facts ...

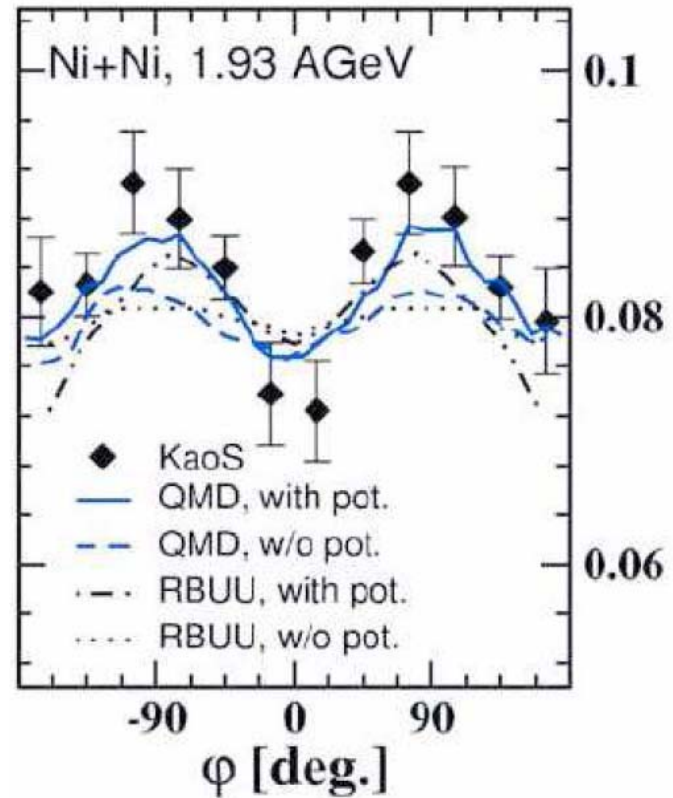
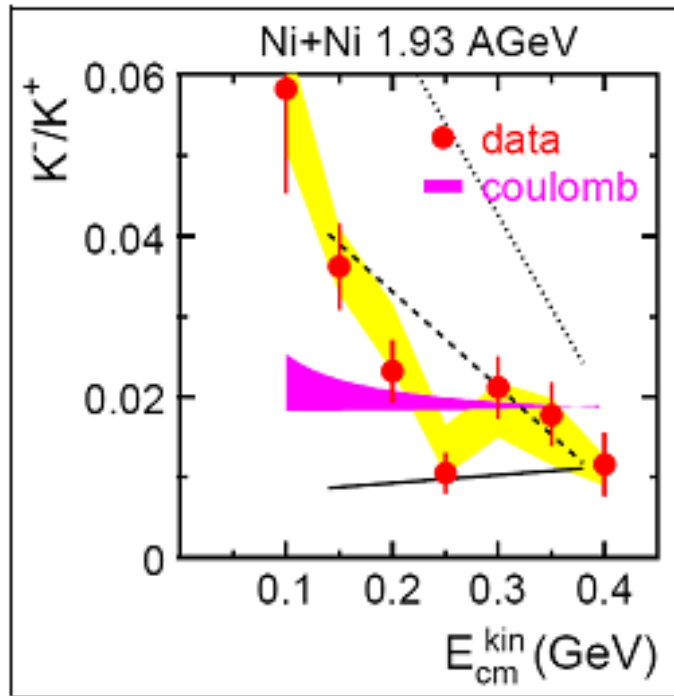

C. Fuchs, *Prog. Part. Nucl. Phys.* **56** (2006) 1

	U(K+)	U(K-) (MeV)
.....	30	-120
----	30	-70
—	0	0

Ratio of K^-/K^+ emission

