

Few-Body Systems

Testing different pieces of the
few-nucleon system interaction models
with the help of $^1\text{H}(\vec{d}, pp)n$ breakup reaction



Stanisław Kistryn
Institute of Physics
Jagiellonian University
Kraków, Poland

Nucleon-Nucleon Interaction

Basis of Nuclear Physics

Modern NN potentials are in general able to

- ❖ reproduce properties of nuclear matter (eq. of state)
- ❖ reproduce binding energies of light nuclei
- ❖ reproduce global features of the bulk of the scattering observables in 2N and 3N systems

Role of precise knowledge of few-nucleon system dynamics

- fundamental for description of nuclei and nuclear processes
- key feature for application in calculation/simulation codes (fast reaction stage - INC, QMD, etc.);
radiation shielding, spallation targets, dosimetry, medical irradiation procedures, biological and astrophysical models, ...

Two-Nucleon System

Nucleon-Nucleon Potential

Meson exchange theory of NN force

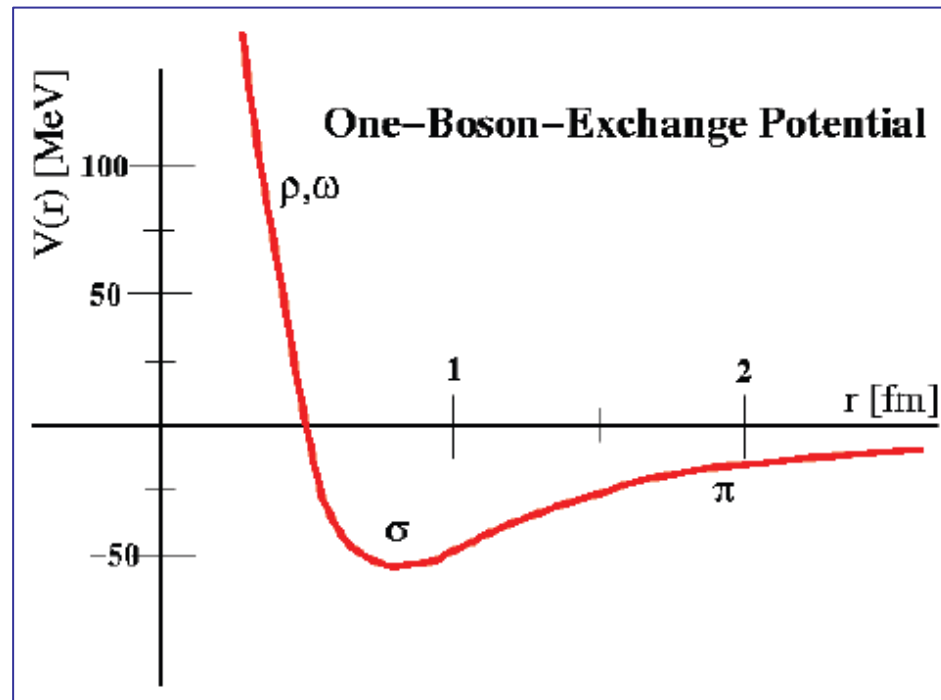

Two-Nucleon System

Standard Interaction Models

- Meson exchange theory of NN forces - nucleonic degrees of freedom (CD Bonn, Nijm I, Nijm II, AV18)
- CD Bonn + explicit treatment of a single Δ -isobar degrees of freedom - coupled barion channels

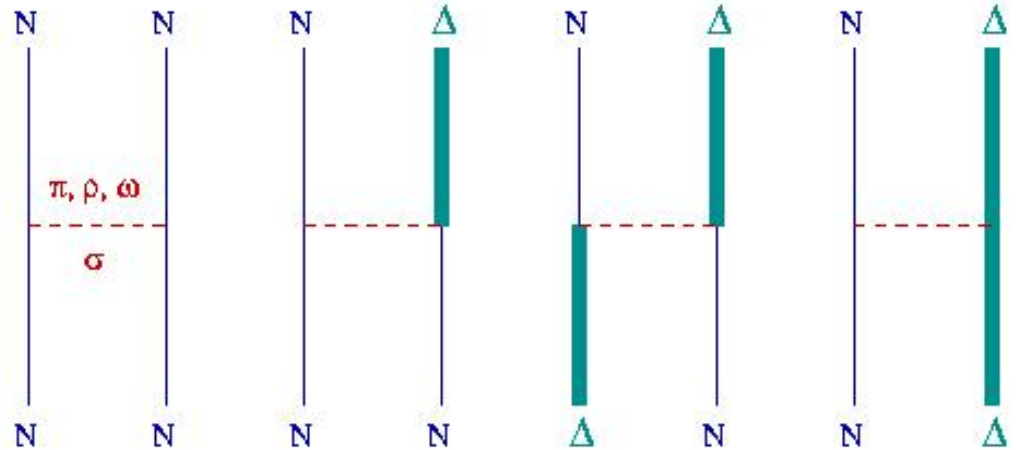
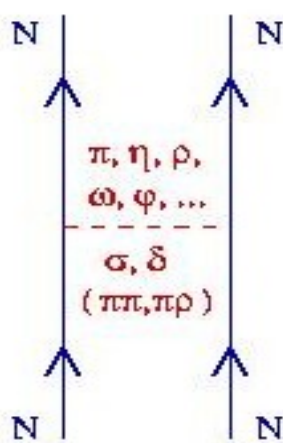

Realistic Potentials

Coupled-Channels Potential

Two-Nucleon System Effective Field Theory

Chiral Perturbation Theory

- NN effective potential obtained by systematic expansion in powers v of small external momenta Q , $(Q/\Lambda_\chi)^v$, with $\Lambda_\chi \approx 1 \text{ GeV}$ (Ch. Sym. breaking scale); "easy" for π - π and π -N scattering amplitude, more demanding for N-N interaction
- Two kinds of contributions:
 - pion(s) exchanges (vertices of different order)
 - contact interactions (low energy constants)

Two-Nucleon System

EFT / ChPT Potential Model

LO:

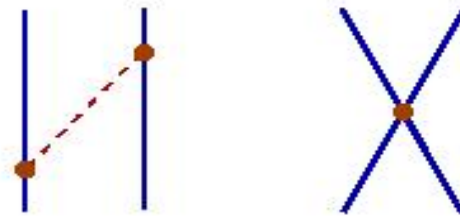

1 π exchange ($v=0$) & 2 LEC's

NLO:

2 π exchanges

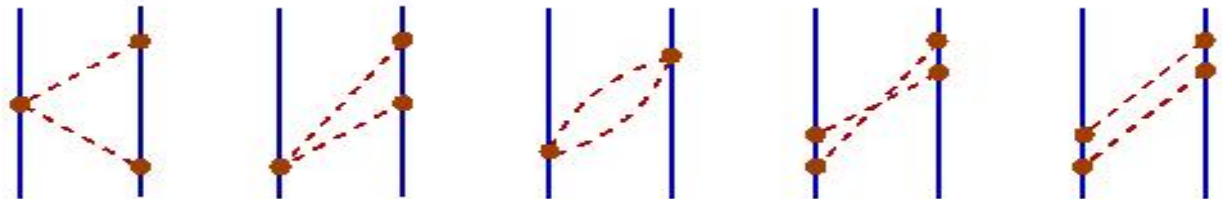

& 7 LEC's ($v=2$)
& corrections to
1 π exchange

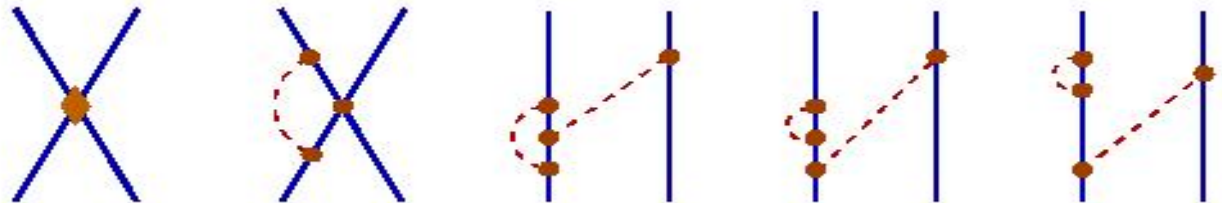

NNLO:

2 π exch. ($v=3$),
& corrections

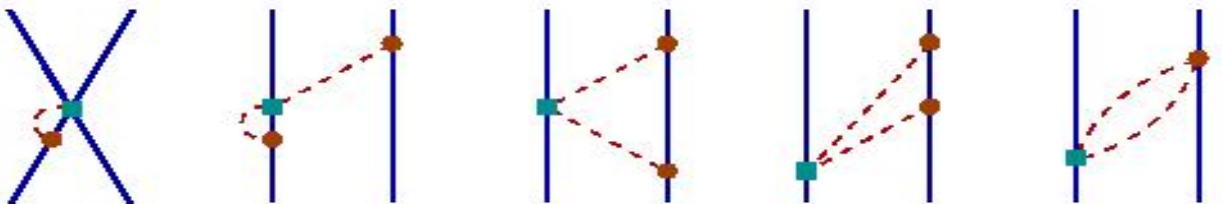

Two-Nucleon System

Description of Data

Modern realistic NN potentials provide an excellent fit of all data from the 2N system

χ^2 / data point

	CD Bonn	NijmI	NijmII	Av18	Coupl.Ch.
No. of parameters	45	41	47	40	~40
pp data	1.01	1.03	1.03	1.35	1.02
np data	1.02	1.03	1.03	1.07	1.03

Also the EFT/ChPT approach, with increasing order describes the 2N system very accurately - significant improvement from NLO to NNLO to NNNLO (26 LECs)

Is Two-Nucleon Dynamics Enough ?

- ❑ Three-nucleon system is the simplest non-trivial environment to test predictions of the NN potential models
- ❑ Needed theoretical formalism which allows to conclude on **physical input** underlying the calculated observables; i.e. avoiding any approximations of the assumed dynamics (due to numerical complexity)



Numerical solutions of the Faddeev equations
(W.Glöckle, H.Wiata et al.)

Three-Nucleon System Faddeev Equations

Operators T_1, T_2, T_3 , according to the **last** pairwise NN int.:

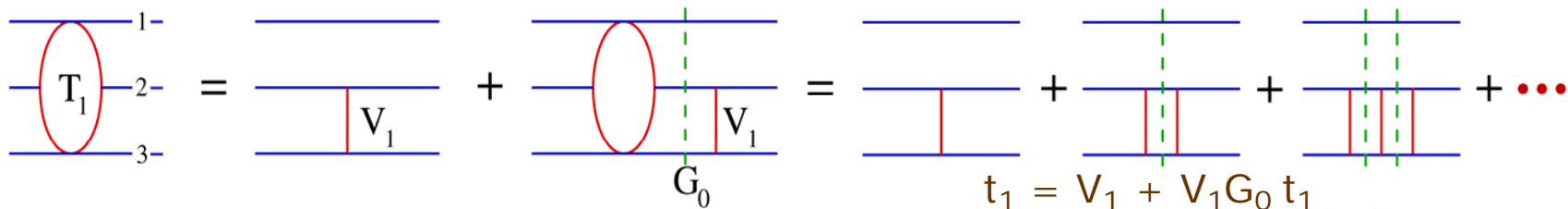

$$T_1 = t_1 + t_1 G_0 (T_2 + T_3)$$

$$\boxed{T = tP + tPG_0T}$$

E.g. amplitude for breakup:

$$U_0 = (1 + P)T \rightarrow \text{Observables}$$

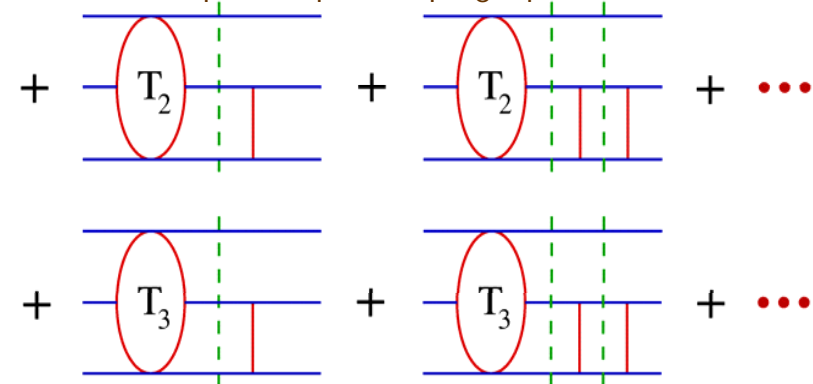

Solution in partial-wave basis (off-shell t) – up to j_{\max} & J_{\max}

RP: $j_{\max}(\text{NN}) = 5, J_{\max}(\text{3N}) = 25/2, J_{\max}(\text{3NF}) = 13/2$

CC: $j_{\max}(\text{NN}) = 5, j_{\max}(\text{N}\Delta) = 4, J_{\max}(\text{3B}) = 31/2$

Is Two-Nucleon Dynamics Enough ?

Bound States of Few Nucleons

	${}^3\text{H}$	${}^3\text{He}$	${}^4\text{He}$
Experimental	-8.48	-7.72	-28.3
CD Bonn	-8.01	-7.29	-26.3
NijmII	-7.66	-7.01	-24.6
Av18	-7.62	-6.92	-24.3
Coupl. Chan.	-8.00	-7.26	-26.1
ChPT-NNLO	-8.04	-7.22	-26.6
INOY-nonlocal	-8.46	-7.70	-29.1

Predictions of NN potentials alone obviously fail to reproduce 3N, 4N binding energies (E_B [MeV])

Elastic Nucleon-Deuteron Scattering Observables

- Differential Cross Section

- Overall strength

- Spin Observables:

- Vector Analyzing Power iT_{11}

- $L \cdot S$ interaction

- Tensor Analyzing Powers T_{20} , T_{21} , T_{22}

- Tensor interaction (D-state)

- $(L \cdot S)^2$ interaction

- Correlation Coefficients $C_{ij}^{k'}$

- Transfer Coefficients $K_{ij}^{k'}$

- Spin-Spin interaction

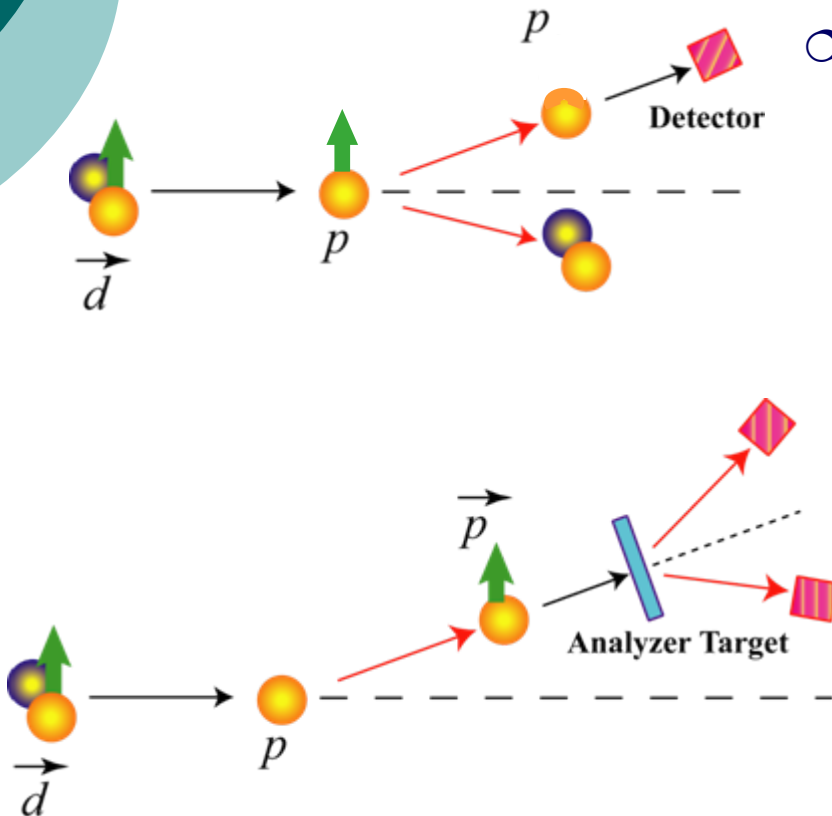

Is Two-Nucleon Dynamics Enough ?

Total Cross Section

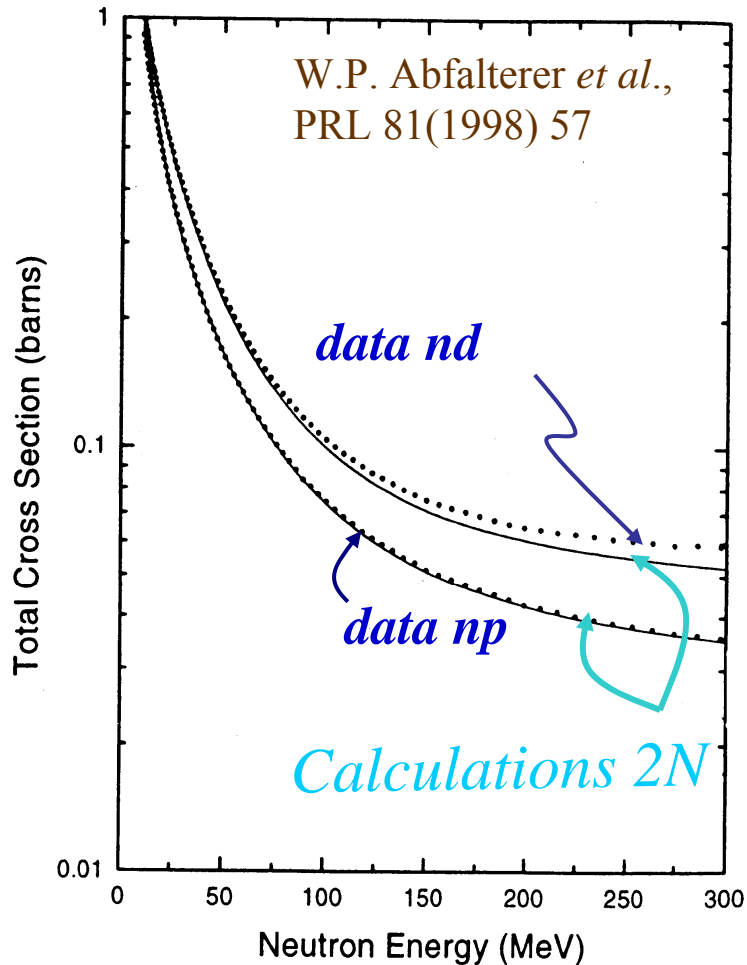

Predictions of NN potentials
cannot reproduce energy
dependence of the total
cross section of the n+d
scattering

Is Two-Nucleon Dynamics Enough ?

Elastic Nucleon-Deuteron Scattering

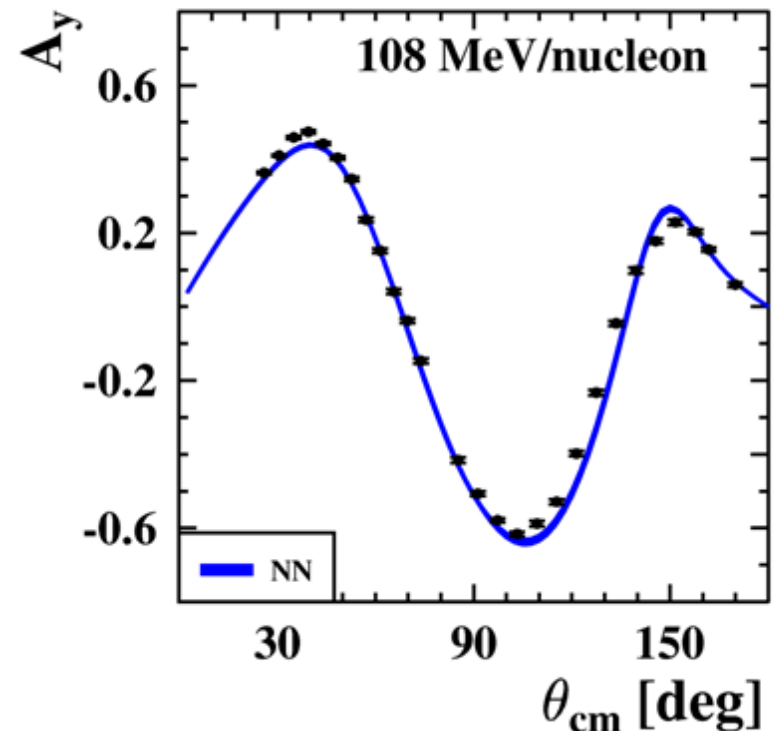
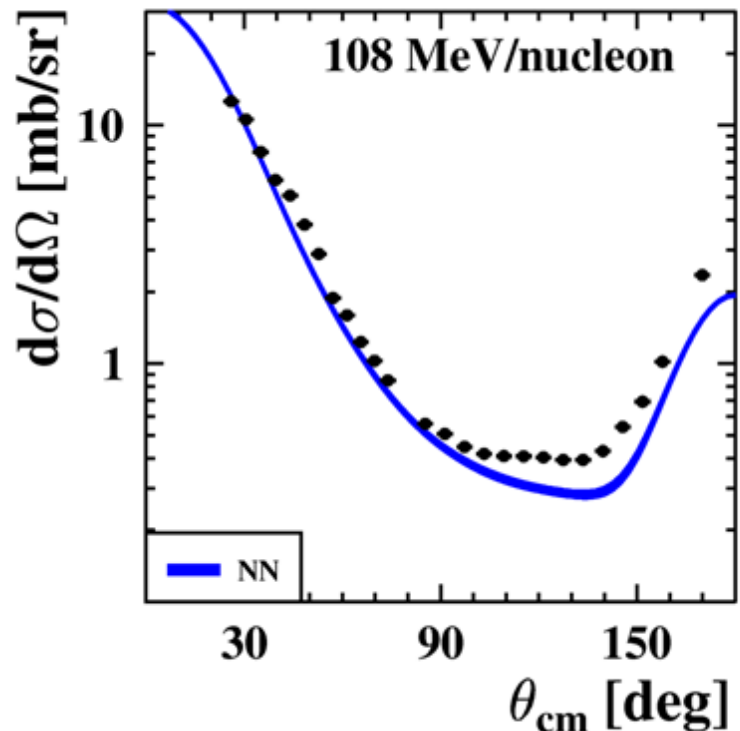

Predictions of NN potentials alone fail to reproduce minimum of the $d(N,N)d$ elastic scattering cross section

Pairwise Nucleon-Nucleon Interaction is not Enough !

- Introducing concept of **three-nucleon forces** :
genuine (irreducible) interaction of three nucleons
 - how well matched to NN potential ?
- Implementing 3NF into Faddeev framework (without affecting numerical accuracy)

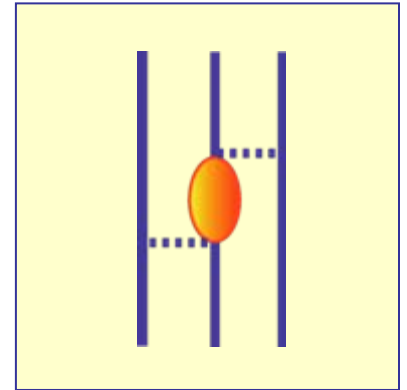

$$V = \sum V_{NN} + V_4$$

$$T = tP + (1 + tG_0)V_4(1 + P) + tPG_0T + (1 + tG_0)V_4(1 + P)G_0T$$

Three-Nucleon System

Realistic/Coupled Channels Pot. & 3NF Models

- Three-nucleon forces - only **weak connection** to the NN potentials (TM99, Urbana IX, Brazil)
- *Competing Δ -excitation effects* (two nucleon dispersion and effective 3NF) - resulting net **Δ influence is rather small**

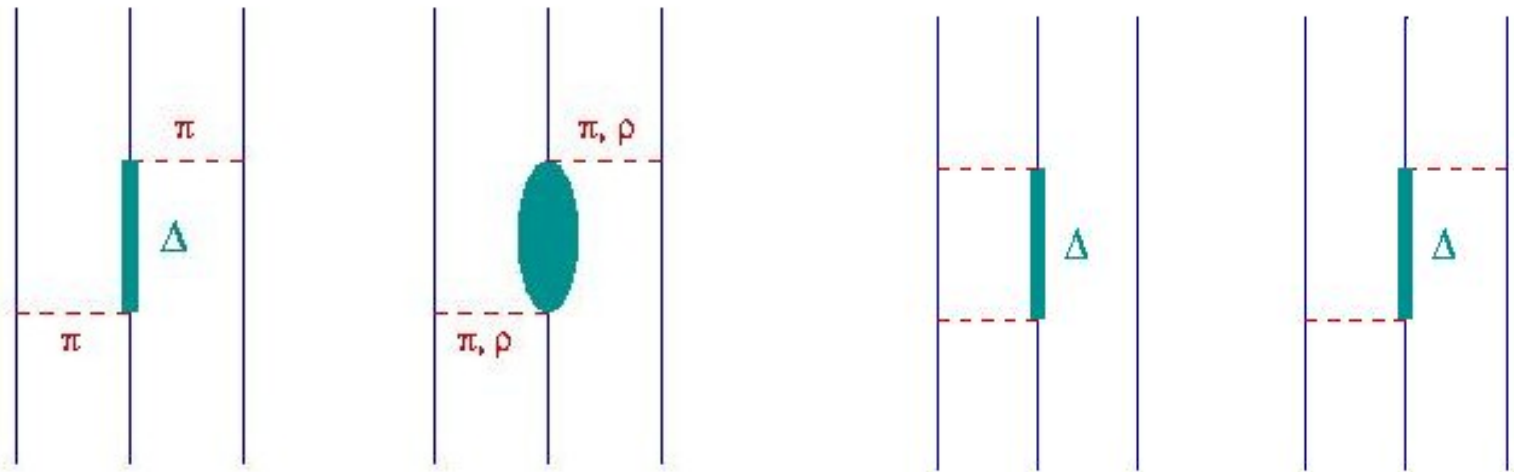

Three-Nucleon System

3NF within ChPT

- Three-nucleon forces appear naturally, **fully consistent** with the 2N graphs

NLO:

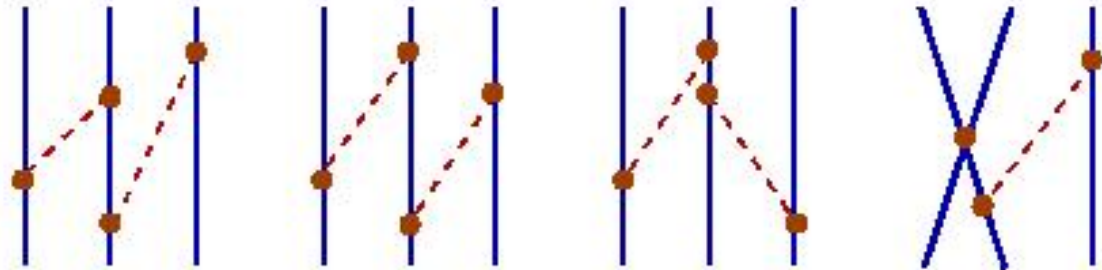

All contributions cancel out !

NNLO:

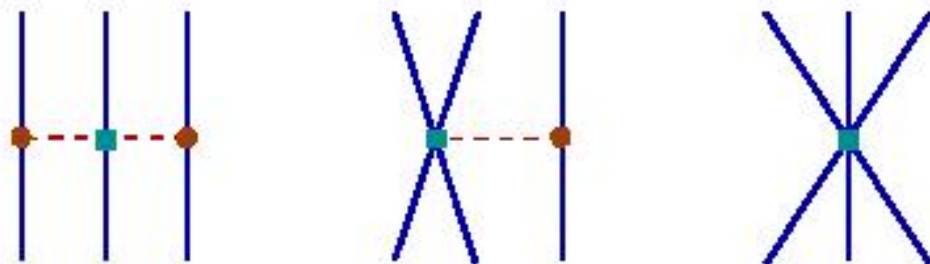

Three possible topologies

3NF Effects

Bound States of Few Nucleons

Predictions of NN potentials with 3NF models for 3N, 4N bounding energies (E_B [MeV]) do much better

	${}^3\text{H}$	${}^3\text{He}$	${}^4\text{He}$
Experimental	-8.48	-7.72	-28.3
CD Bonn	-8.01	-7.29	-26.3
NijmII	-7.66	-7.01	-24.6
Av18	-7.62	-6.92	-24.3
CD Bonn + TM99	-8.48	-7.73	-29.2
NijmII + TM99	-8.39	-7.72	-28.5
Av18 + TM99	-8.48	-7.76	-28.8
Av18 + UIX	-8.48	-7.76	-28.5
CC CD Bonn + Δ	-8.36	-7.64	-28.4

$E_B({}^3\text{H})$
used in
3NF fit

3NF Effects

Bound States of Few Nucleons

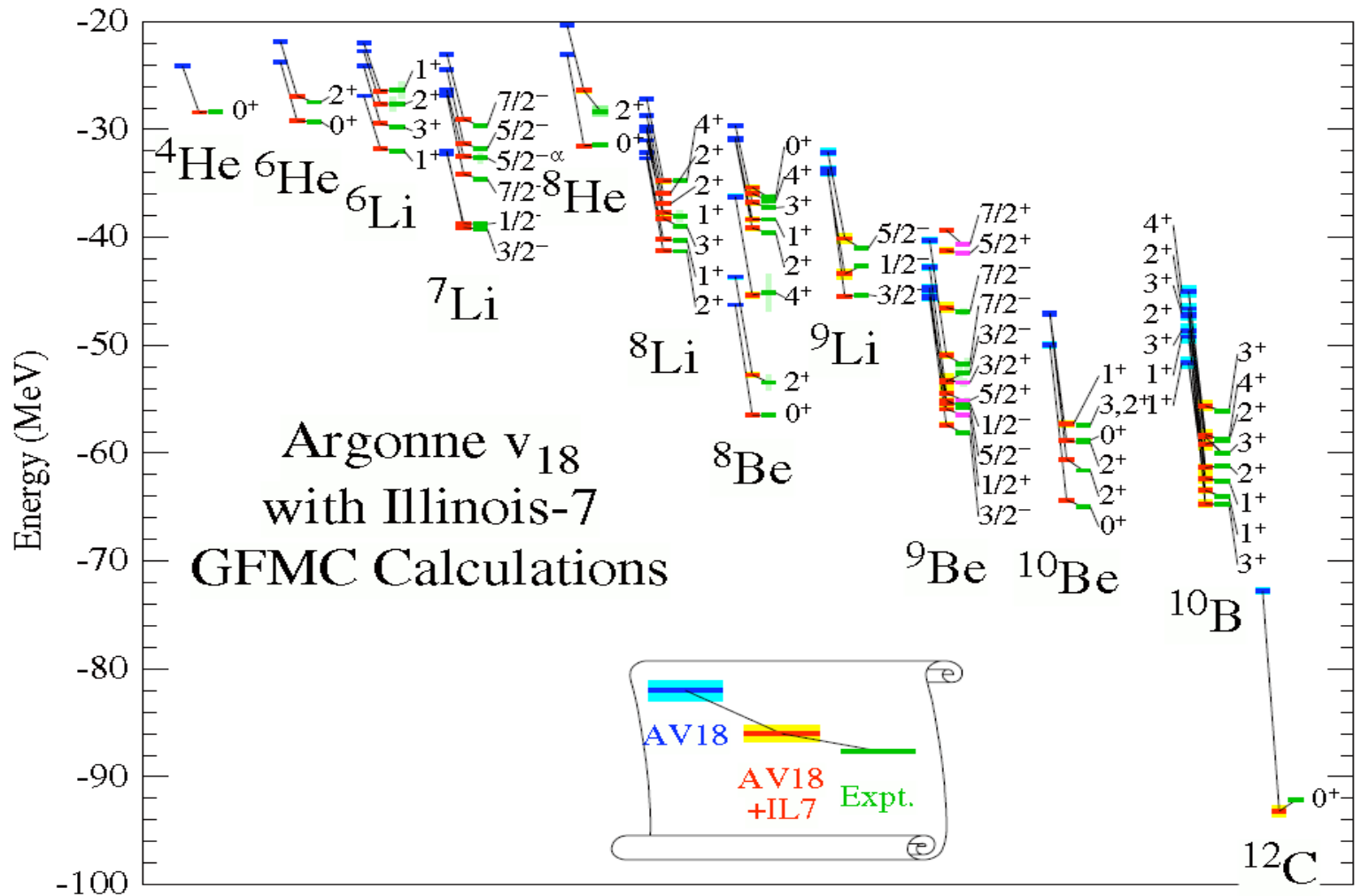

3NF Effects

Elastic Nucleon-Deuteron Scattering

Predictions of NN potentials with 3NF models better reproduce minimum of the $d(N,N)d$ scattering c.s.

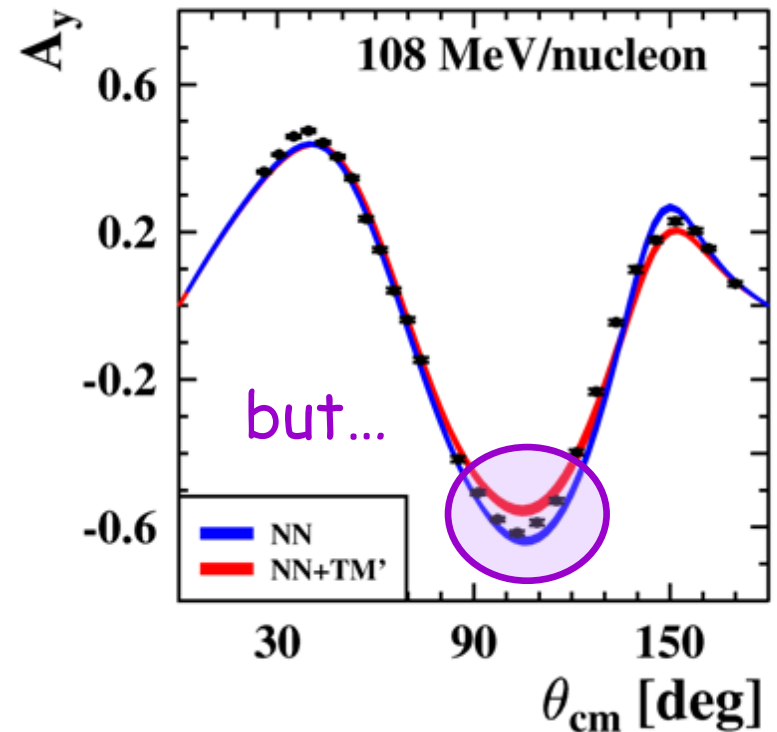
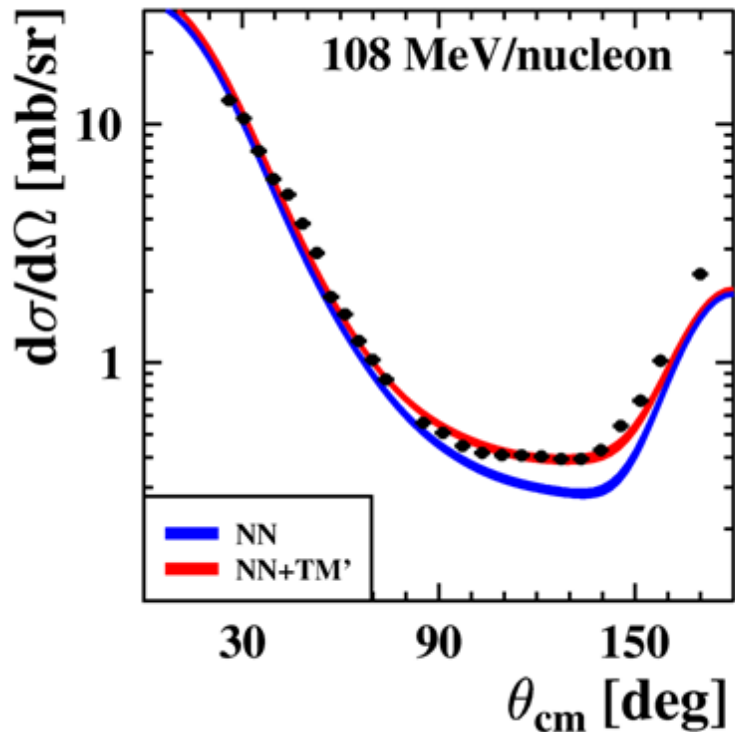

3NF Effects

Elastic Nucleon-Deuteron Scattering

Effects of 3NF in $d(N,N)d$ c.s. minimum are energy dependent - *relative enhancement of the effect with the incident energy*

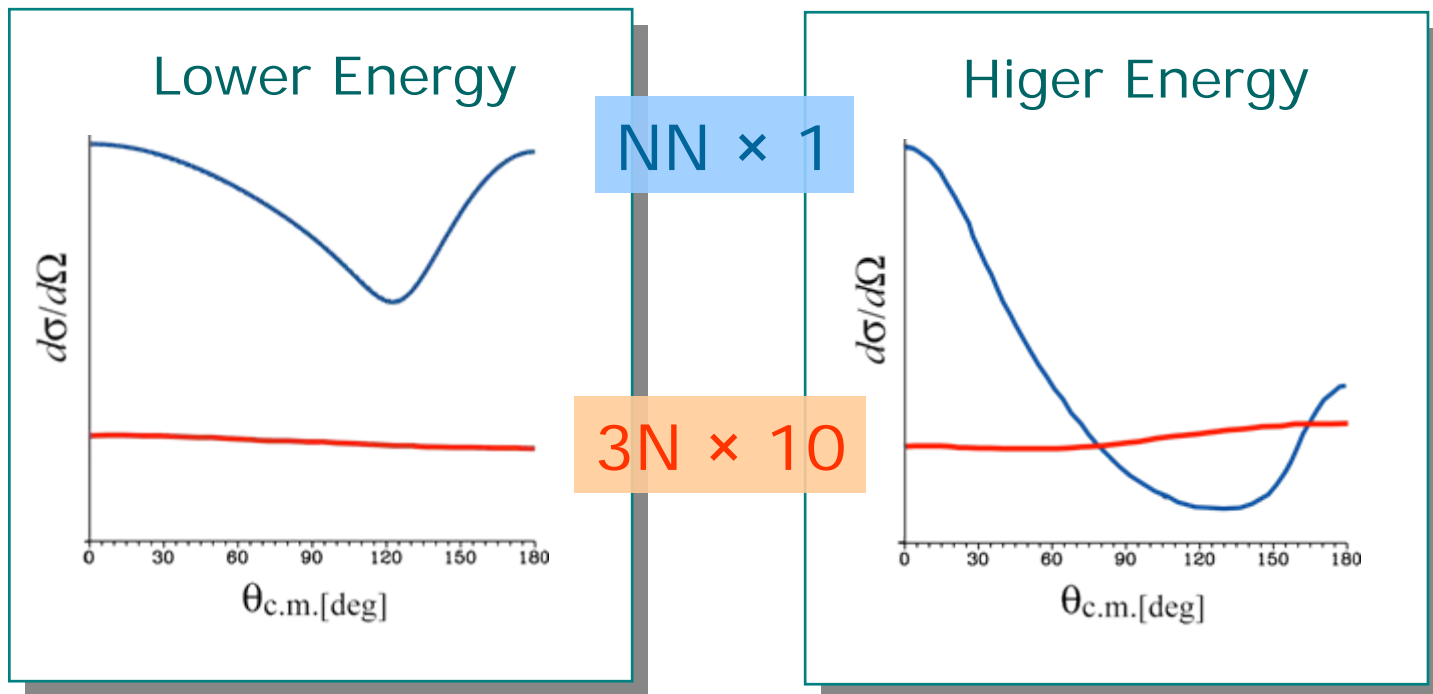

3NF Effects

Elastic Nucleon-Deuteron Scattering

- 2N
- 2N + TM99
- AV18 + UIX

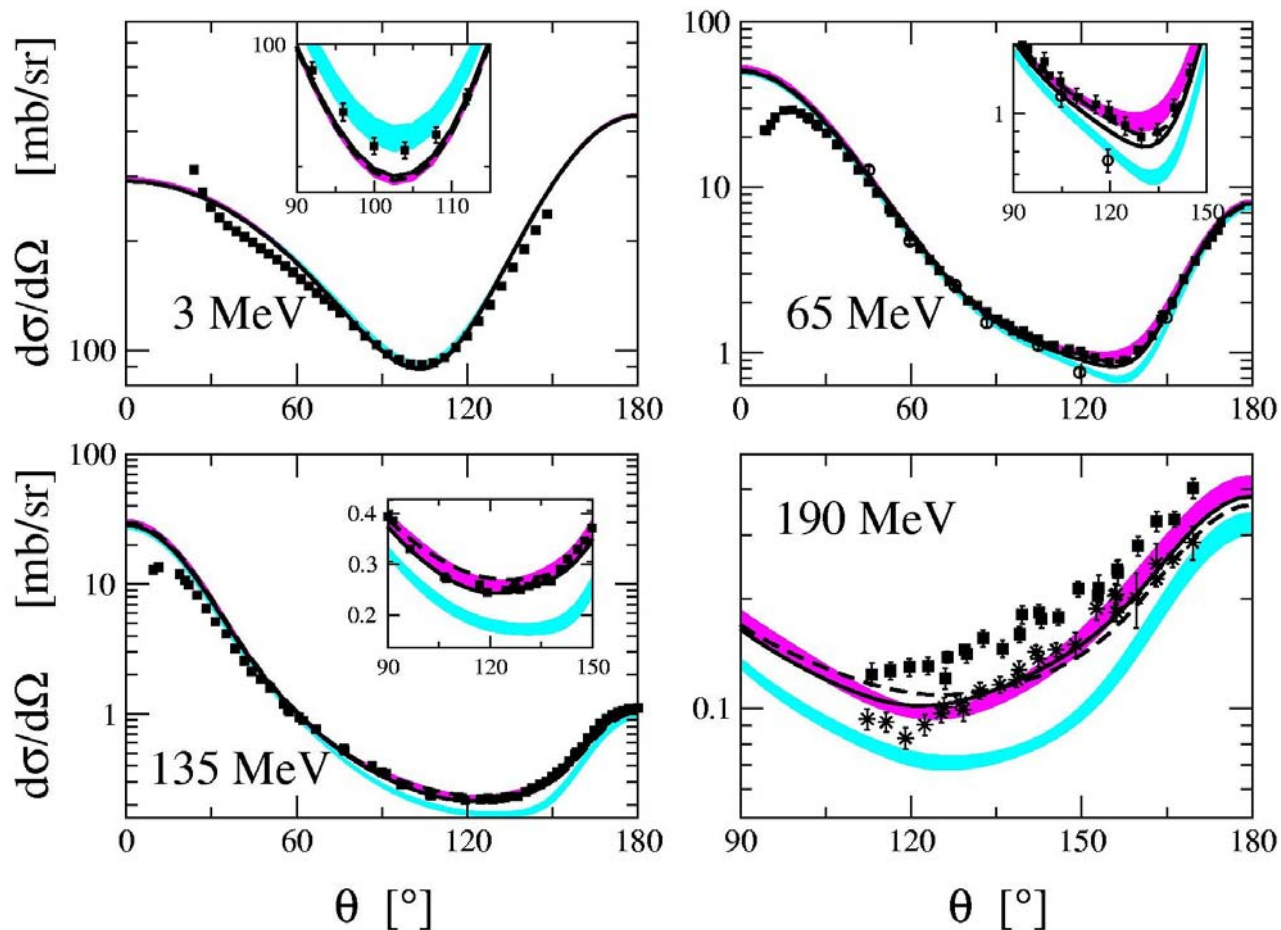

Faddeev calculations

**Realistic NN potentials:
(CD Bonn, NijmI, NijmII,
Av18)**

3NF model: TM99, UIX

3NF Effects

Elastic Nucleon-Deuteron Scattering

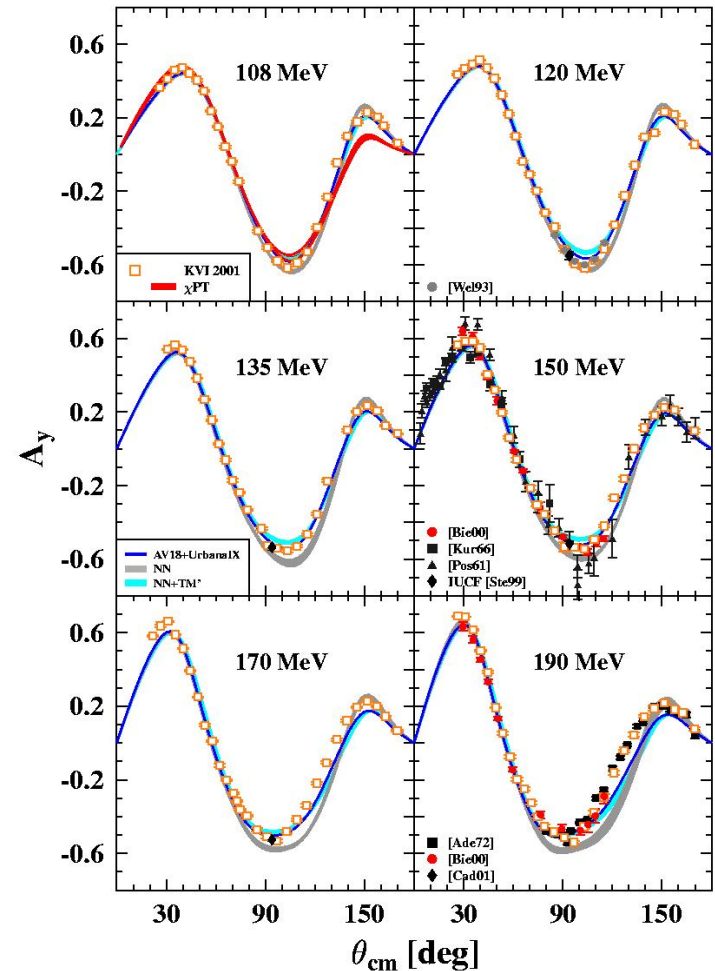
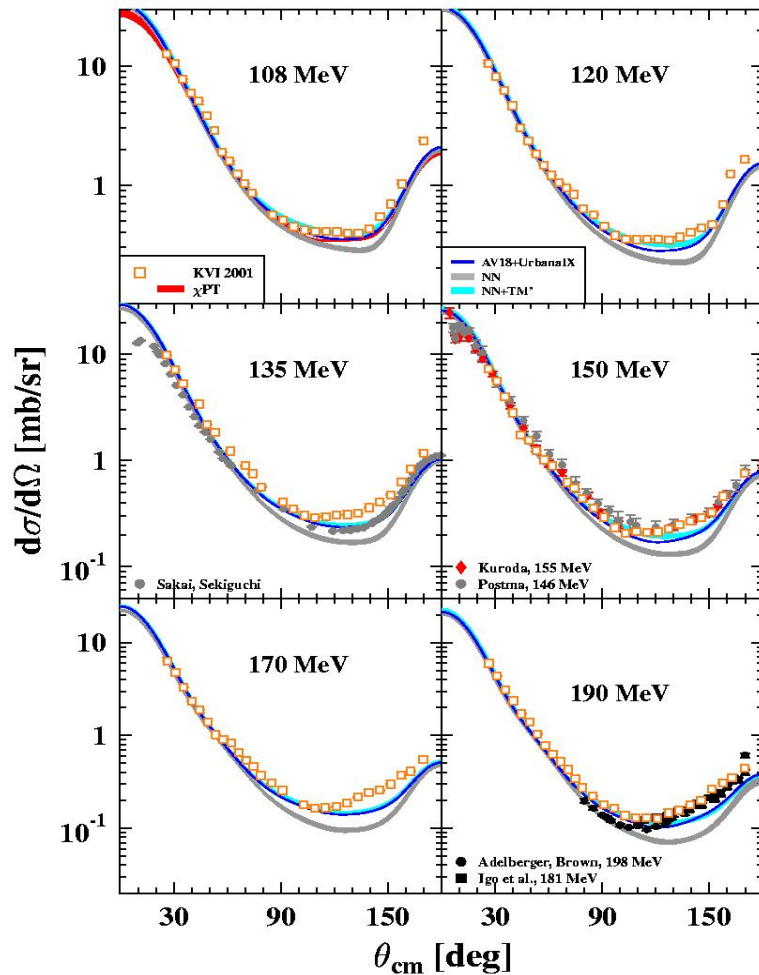

3NF Effects

Elastic Nucleon-Deuteron Scattering

3NF help
 alas, not completely

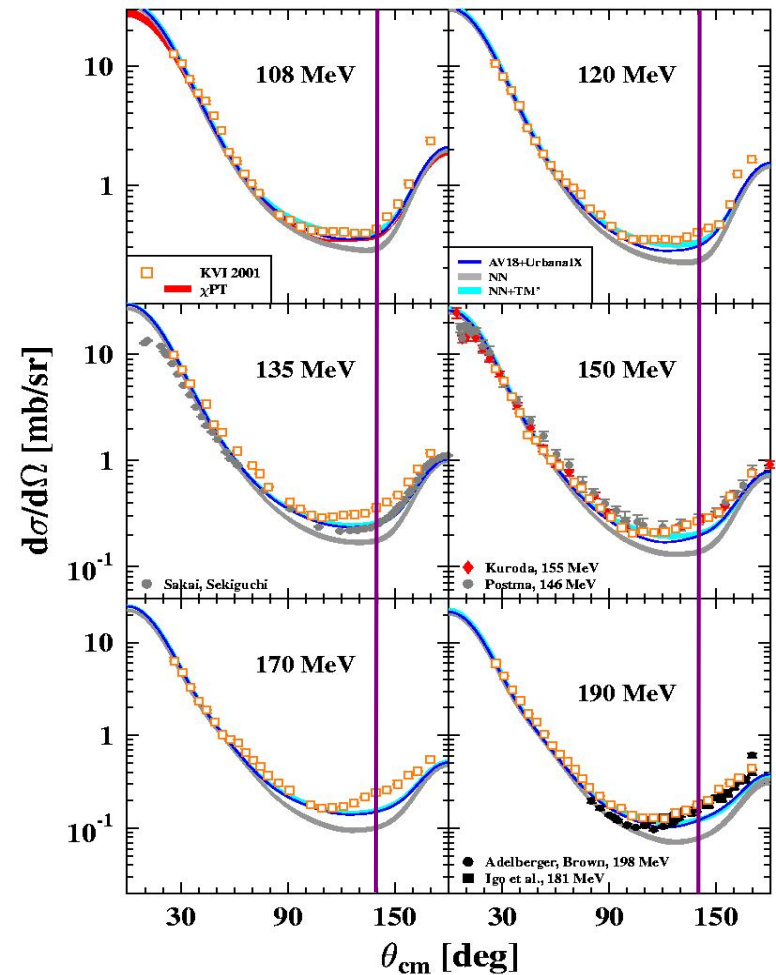
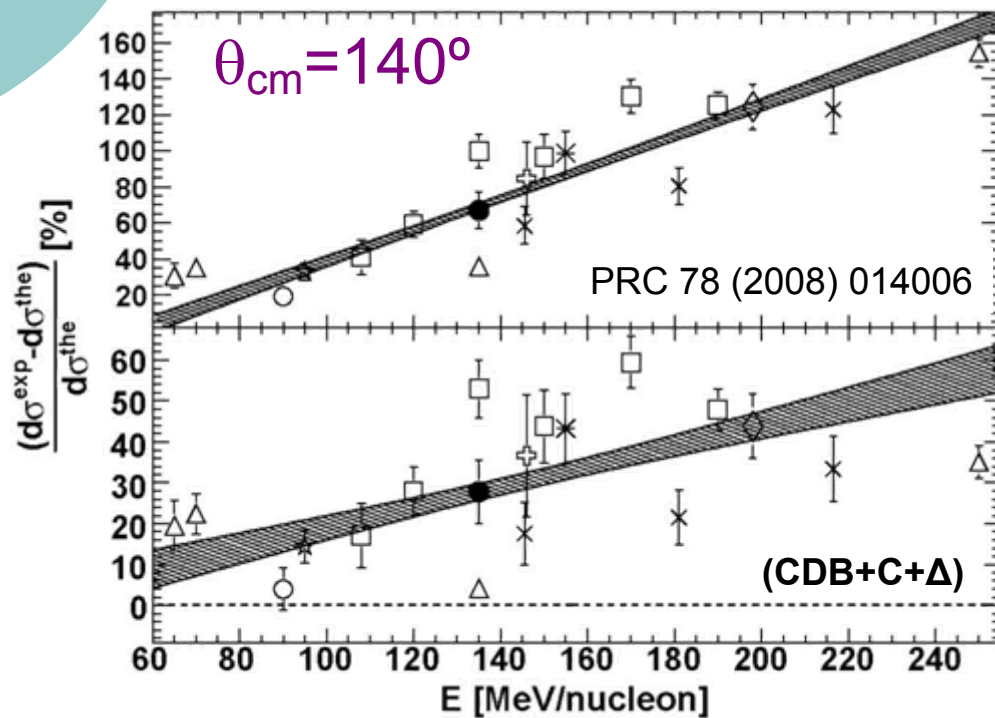

3NF Effects

Elastic Deuteron-Nucleon Scattering

65 MeV/A

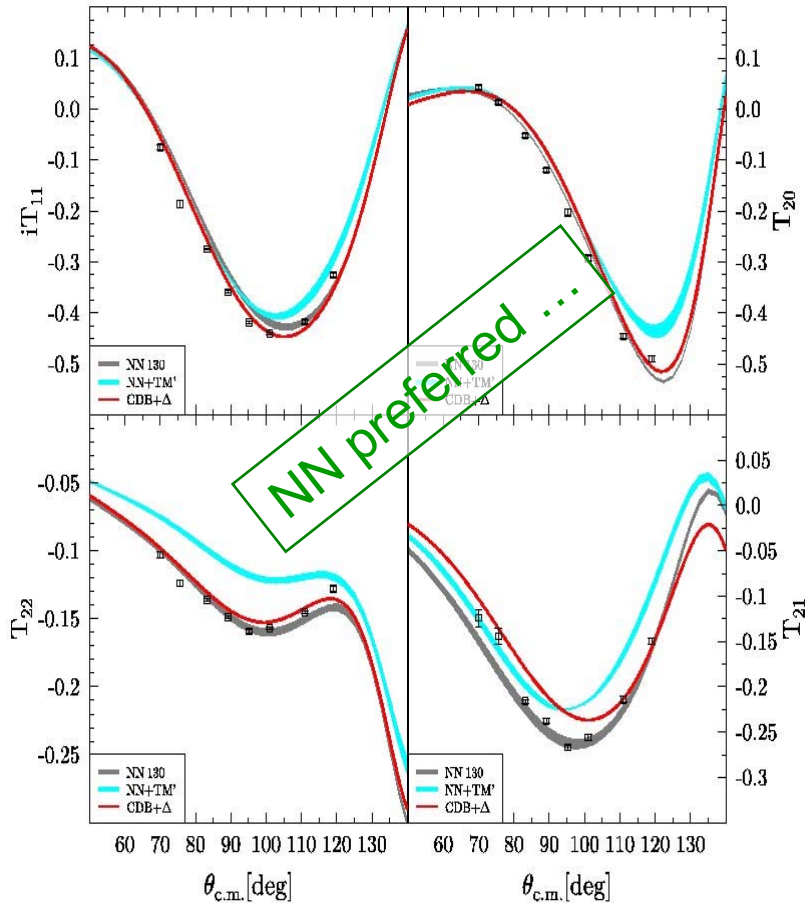

90 MeV/A

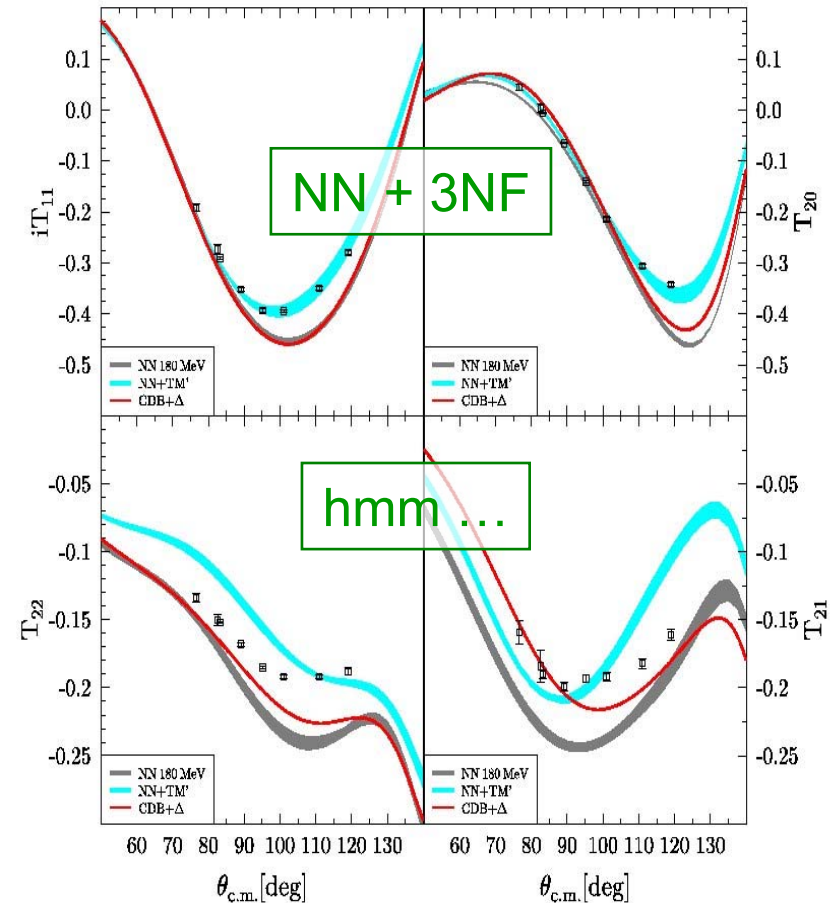

More Dynamical Effects ?

Coulomb force and relativity

Predictions for the N-d elastic scattering

Coulomb

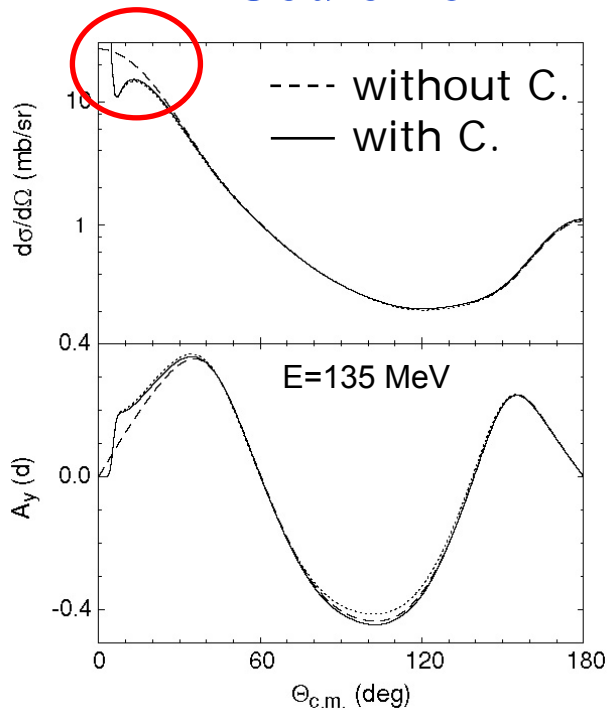

3NF

relativity

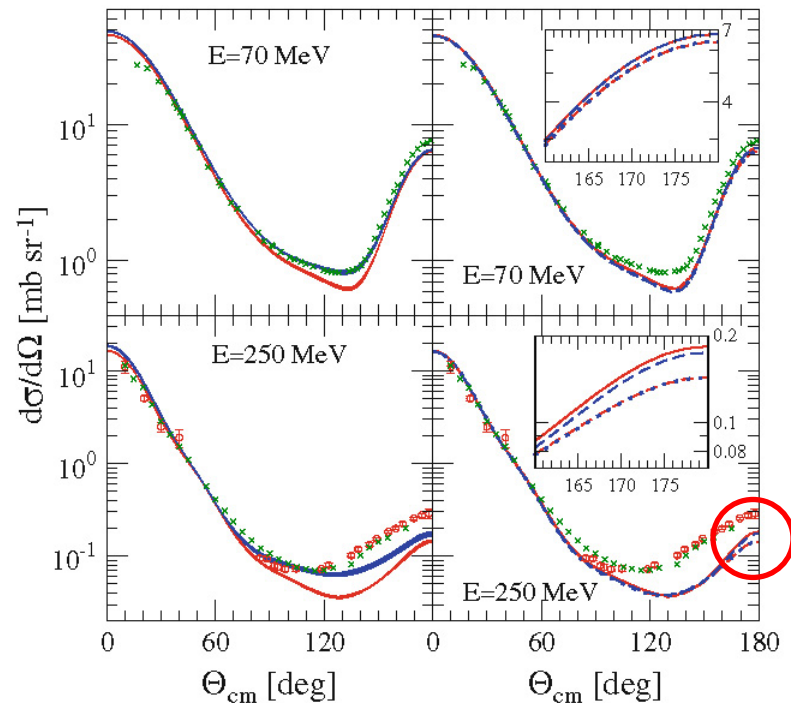

Effects small, located at extreme angles only !

Elastic Nucleon-Deuteron Scattering

RIKEN Facility – SMART

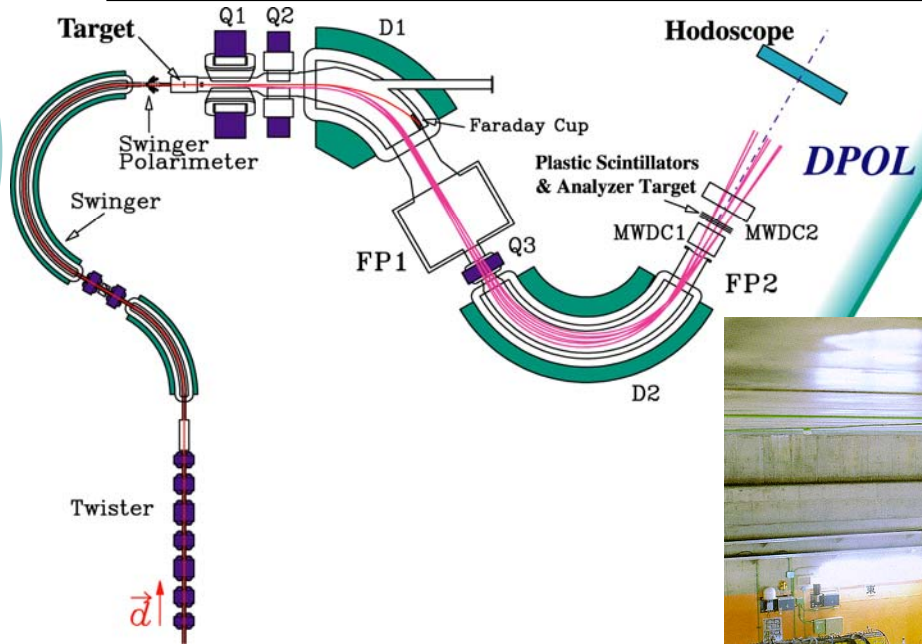

Swinger and Magnetic Analyzer with Rotator and Twister

DPOL

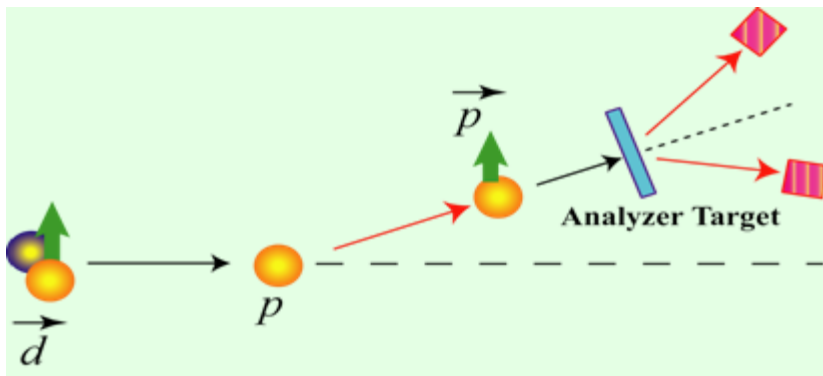

Three-Nucleon System in Continuum

Cross Sections and Analyzing Powers of the $^1\text{H}(\vec{d}, pp)n$ Breakup at 130 MeV

- ❑ Very few breakup data at medium energies (earlier PSI experiments - only 14 kinematical configurations)
 - ❑ To reach meaningful conclusions about the interaction models needed experimental coverage of large phase space regions
 - ❑ Different effects to be traced
 - Influences of 3NF
 - Coulomb force action
 - Relativistic effects
- } Relatively new achievements for breakup !

Breakup Reaction Kinematics

- ❑ Three nucleons in the final state - 9 variables
- ❑ Energy-momentum conservation - 4 equations
- Five independent kinematical variables
 - ✓ Complete (exclusive) exp. - measured ≥ 5
 - ✓ Inclusive exp. - measured ≤ 4 parameters

${}^1\text{H}(d,pp)n$

measured:
directions and
energies of two
protons, i.e.

θ_1, φ_1, E_1

θ_2, φ_2, E_2

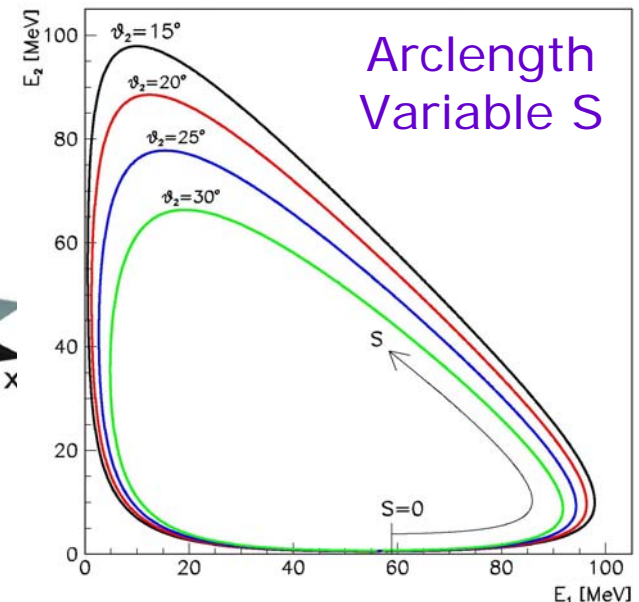
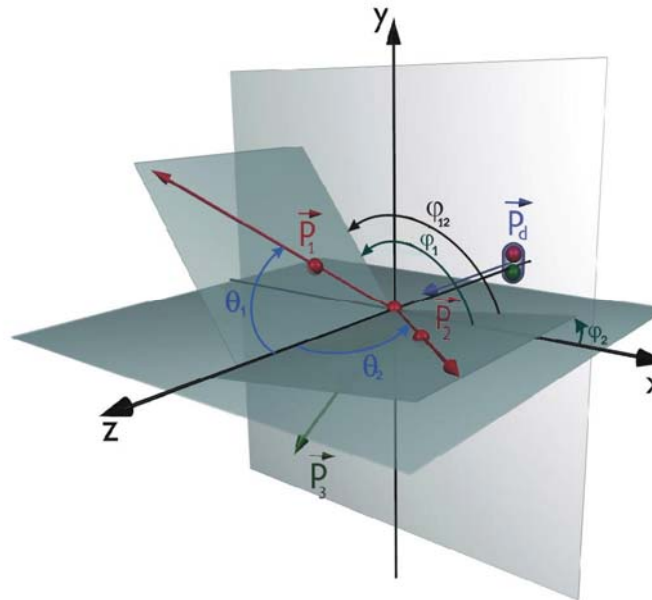

$^1\text{H}(\vec{d}, pp)n$ Measurement at 130 MeV

Experimental Highlights

- ❑ Polarized (vector & tensor) deuteron beam (50 pA, point-like focus on target)
- ❑ Liquid H_2 target (4 mm thickness)
- ❑ Determination of energies and emission angles of both protons
- ❑ Simultaneous measurement of the d-p elastic scattering channel
 - Absolute cross section normalization
 - Polarization monitoring
 - Geometry checks

${}^1\text{H}(\vec{d}, pp)n$ Measurement at 130 MeV Kernfysisch Versneller Instituut, Groningen



${}^1\text{H}(\vec{d}, pp)n$ Measurement at 130 MeV

Small Area Large Acceptance Detector

- ✓ 140 ΔE -E telescopes
- ✓ 3-plane MWPC
- ➔ Angular range :
 $\theta = (12^\circ, 35^\circ)$, $\phi = (0^\circ, 360^\circ)$

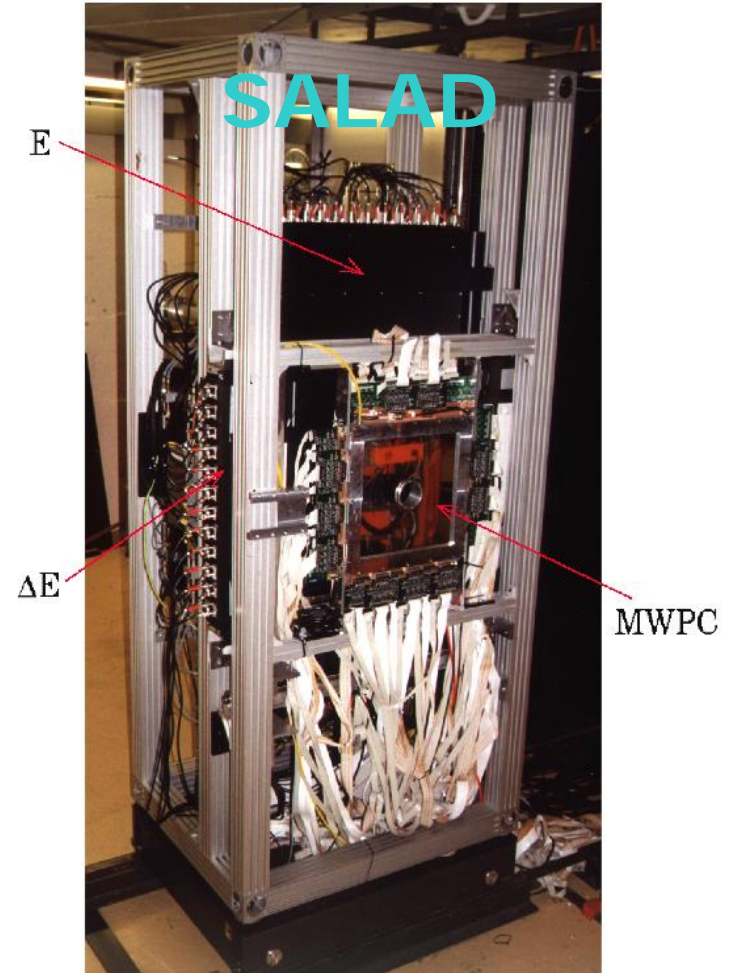
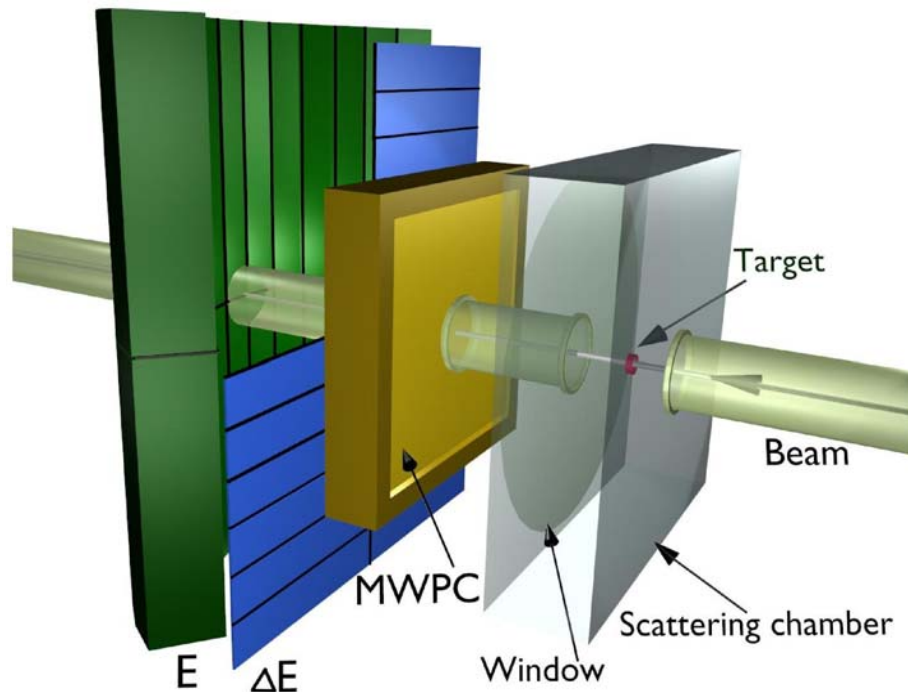

$^1\text{H}(\vec{d}, pp)n$ Measurement at 130 MeV

On-Line Event Classification (Trigger Logic)

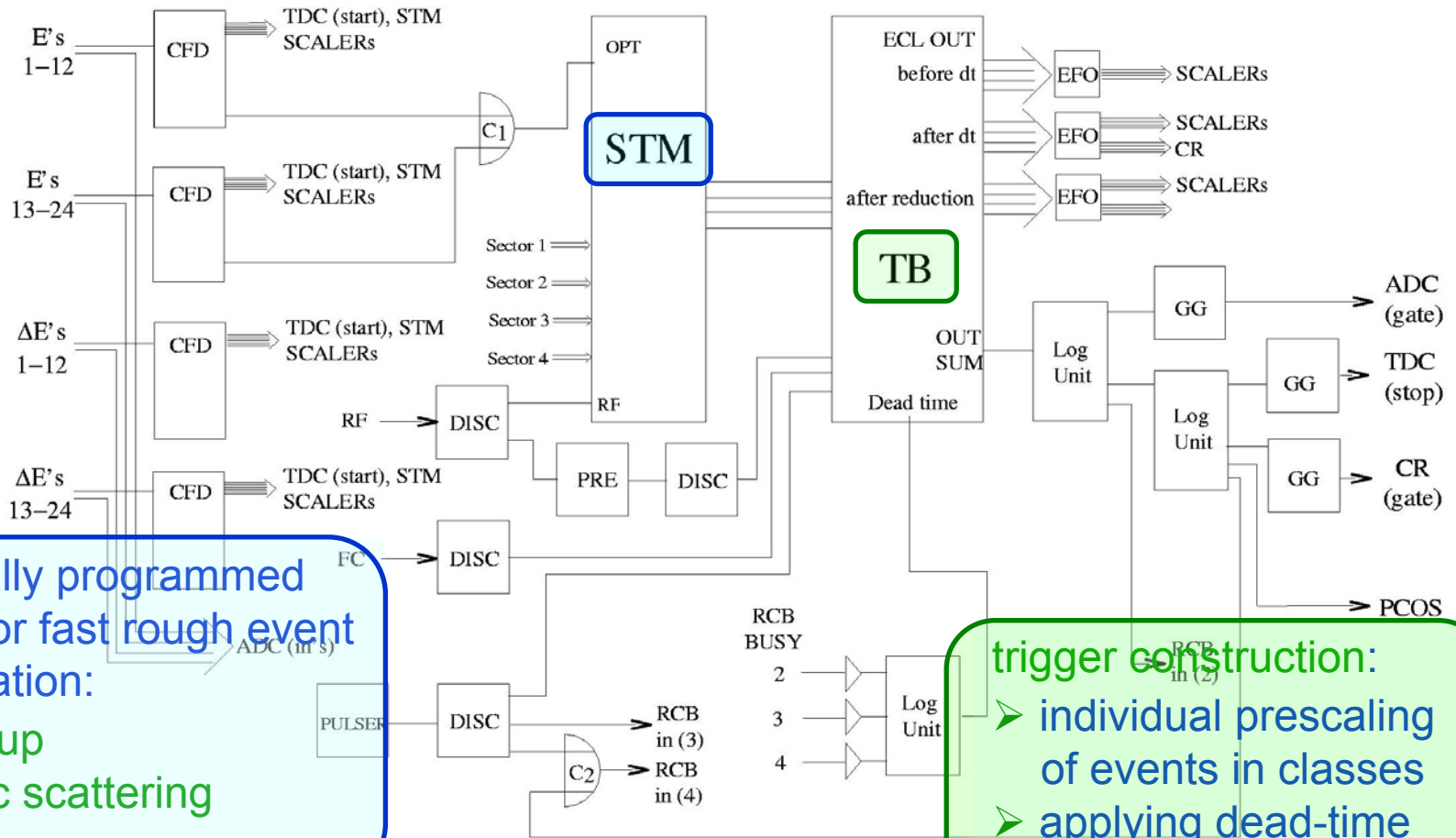

$^1\text{H}(\vec{d}, pp)n$ Measurement at 130 MeV Apparatus – SALAD Detector

Projection of ΔE -E telescopes on the MWPC

Trigger definitions:

1. Single events ●
2. Coincidences - elastic scattering candidates ●
3. Coincidences - breakup events
 - adjacent sectors ●
 - single sector ●

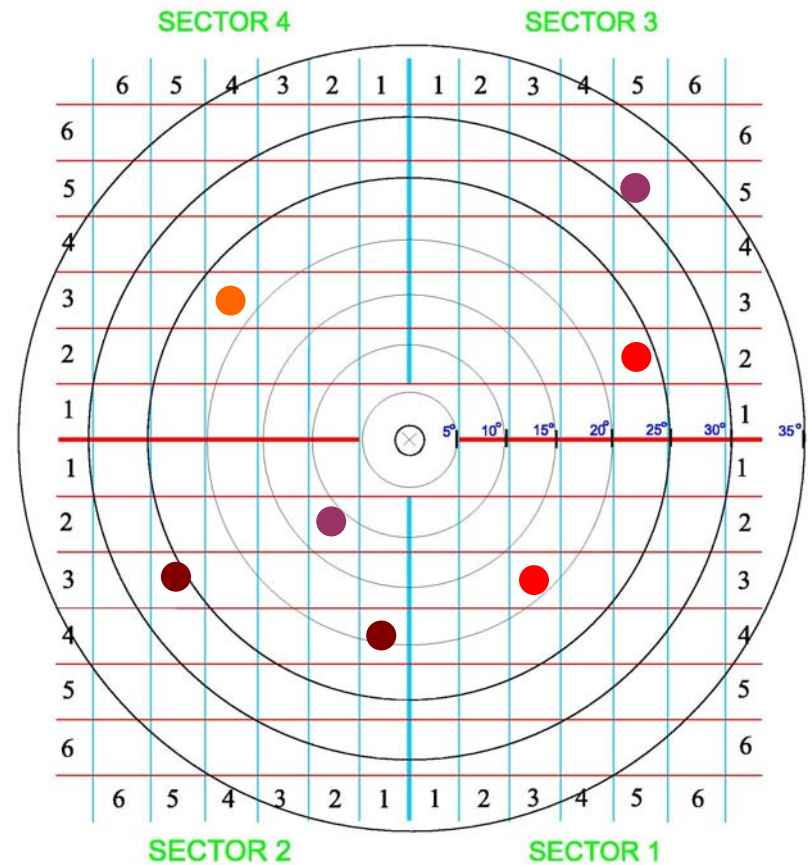

$^1\text{H}(\vec{d}, pp)n$ Measurement at 130 MeV

Data Analysis – ΔE -E Particle Identification

Perfect p vs. d
separation in all
140 individual
 ΔE -E telescopes

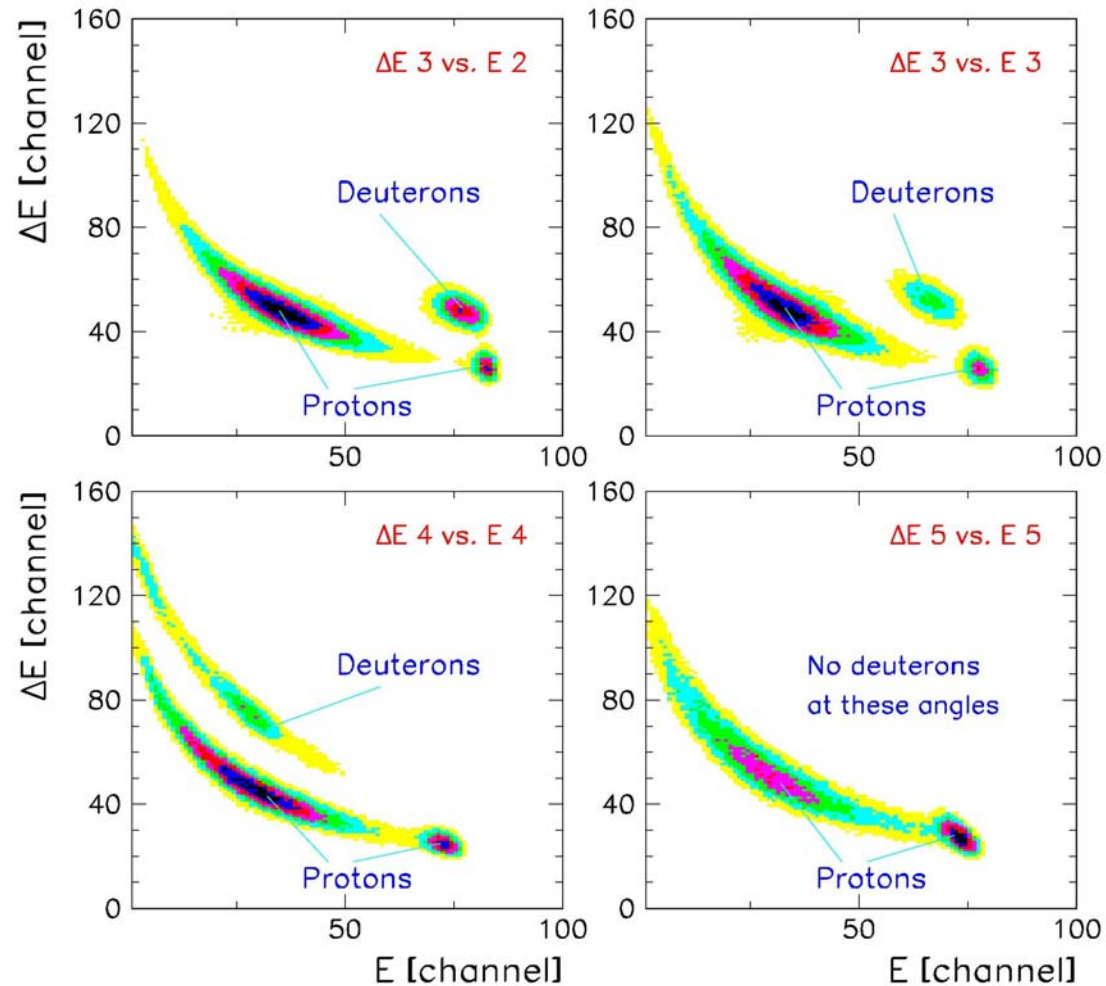

$^1\text{H}(\vec{d}, pp)n$ Measurement at 130 MeV

Data Analysis – E_1 - E_2 Kinematical Spectra

Narrow and
background-free
kinematical spectra
over the whole
angular range

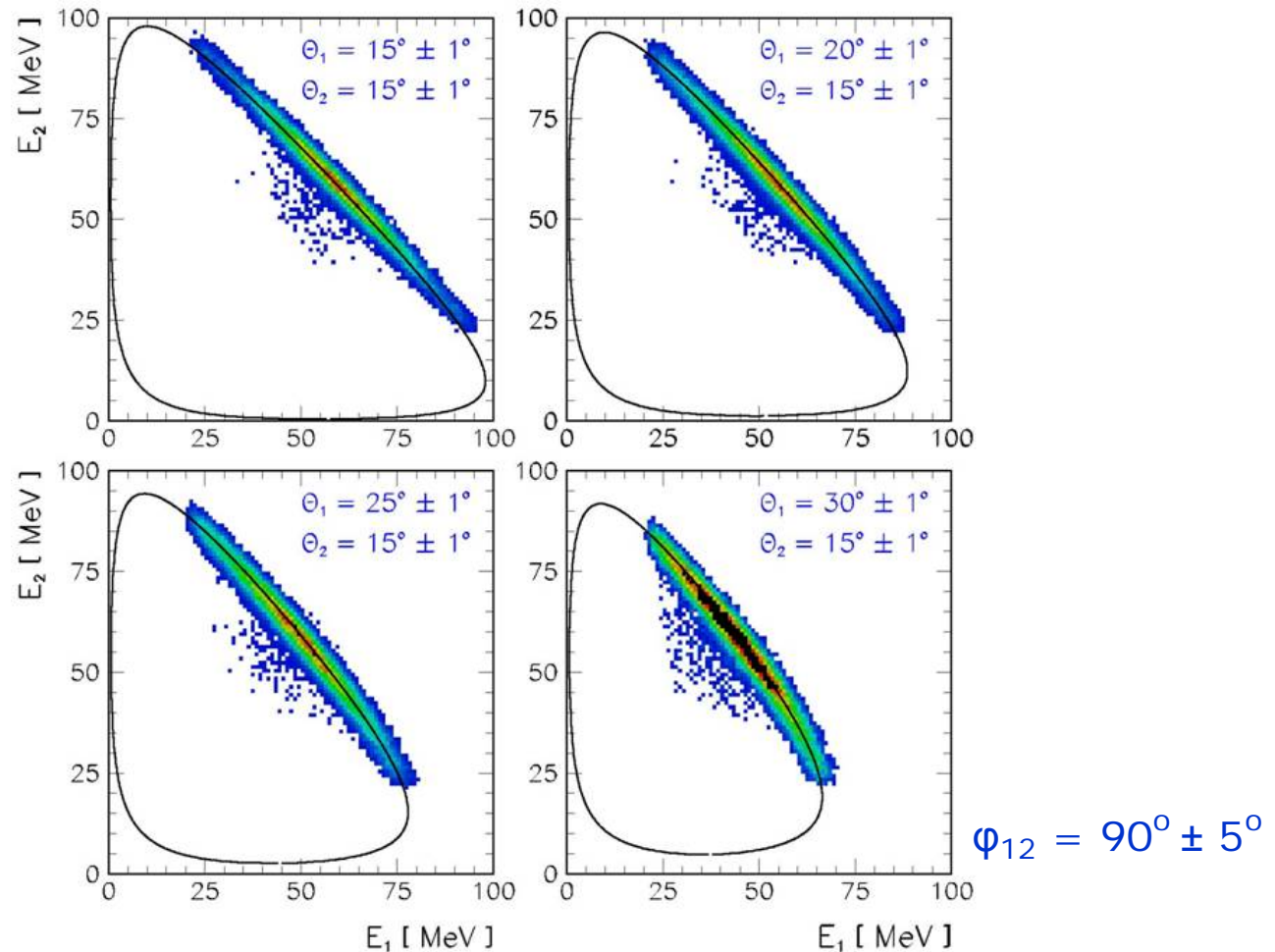

$^1\text{H}(\vec{d}, pp)n$ Measurement at 130 MeV

Data Analysis – ΔE -E Array Image on MWPC

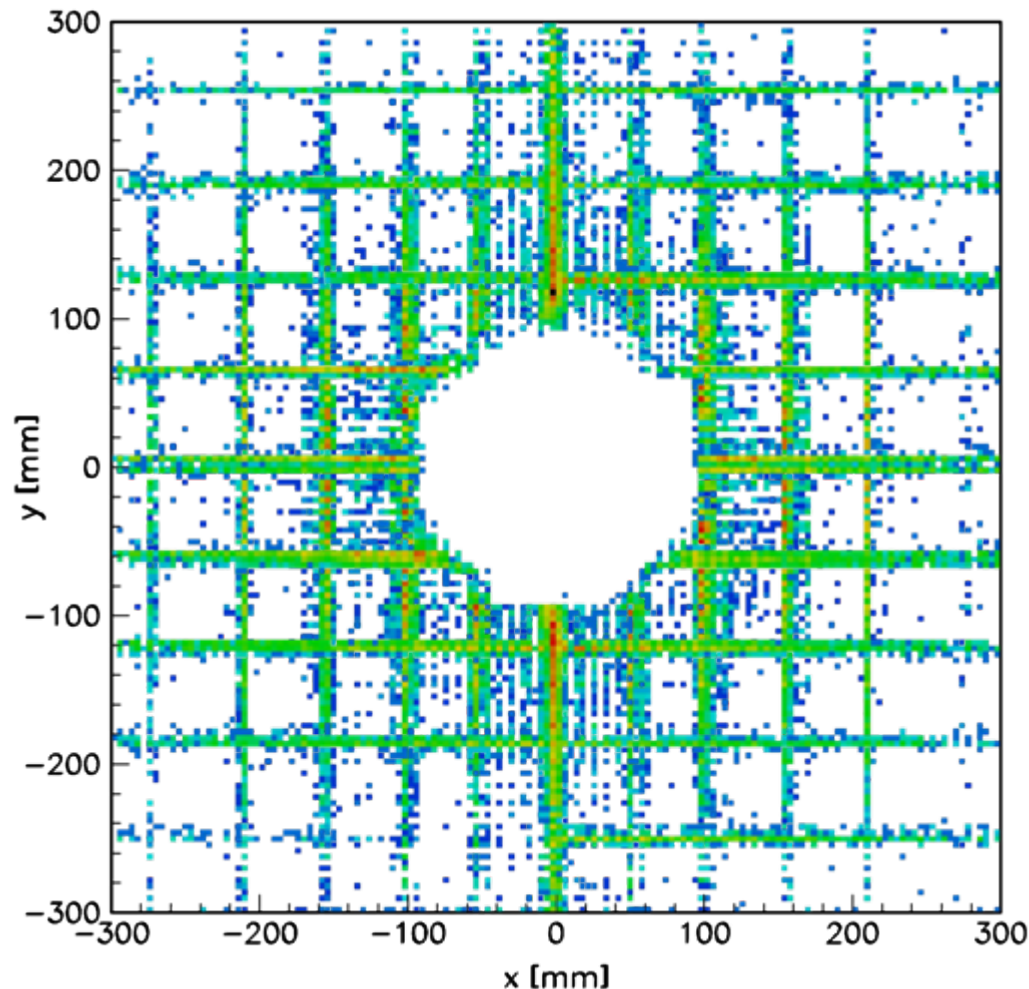

MWPC projections for certain single events:

1. Condition:
no hit in ΔE detector
 2. Condition:
hits in 2 adjacent E detectors
- 1 & 2 overlaid:
image of ΔE -E telescopes on the MWPC plane

$^1\text{H}(\vec{d}, pp)n$ Measurement at 130 MeV

Data Analysis – E_1 - E_2 Kinematical Spectra

Projection of events on the kinematical curve

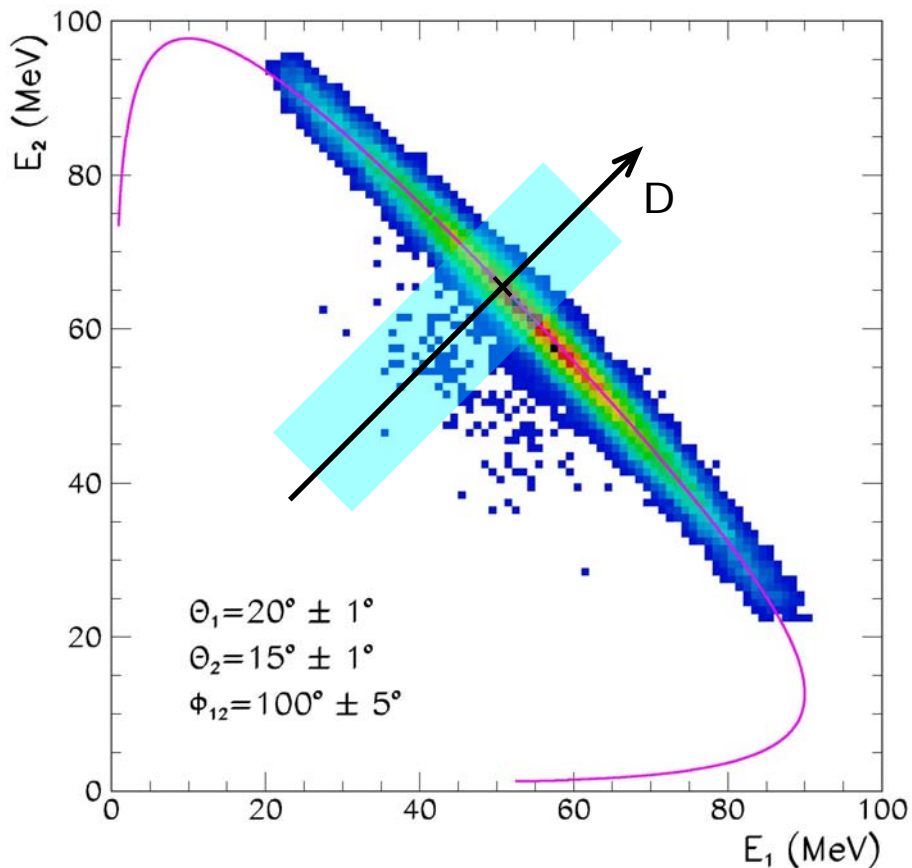

Background subtraction

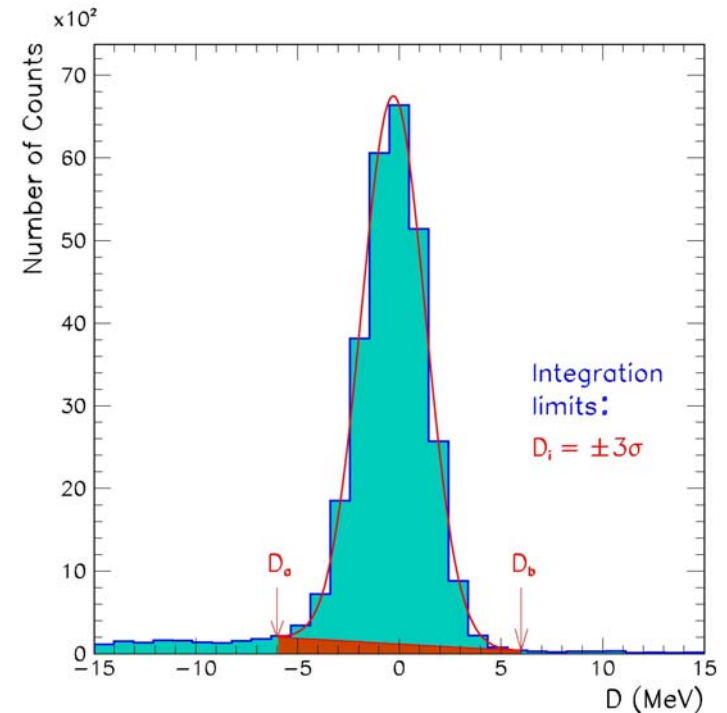

$^1\text{H}(\vec{d}, pp)n$ Measurement at 130 MeV

Data Analysis – Cross Section Normalization

Reliable normalization of the breakup cross sections to the simultaneously measured $^1\text{H}(d, pd)$ elastic scattering

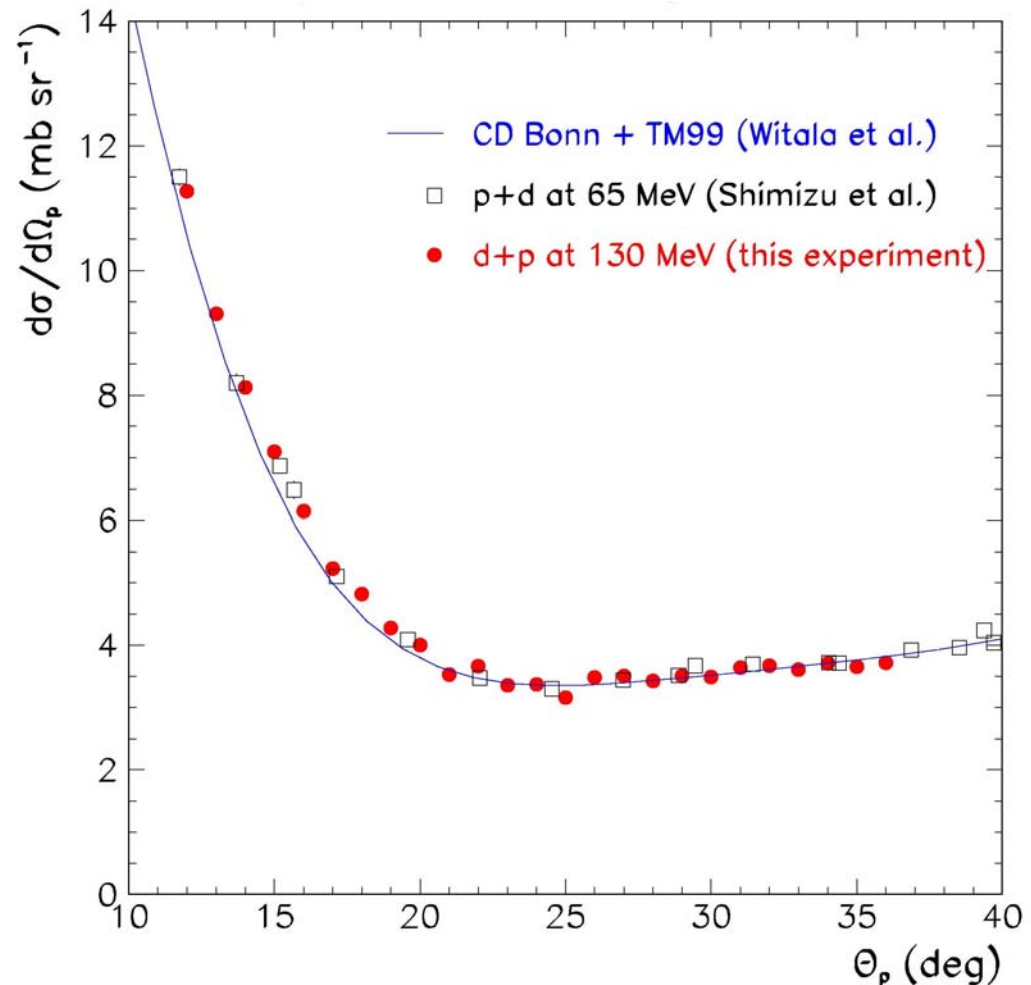

$^1\text{H}(\vec{d}, pp)n$ Measurement at 130 MeV

Data Analysis – Cross Section Normalization

Rate of breakup p-p coincidences:

$$N_{\text{br}}(S, \Omega_1, \Omega_2) = \frac{d^5\sigma}{d\Omega_1 d\Omega_2 dS}(S, \Omega_1, \Omega_2) \cdot \Delta\Omega_1 \Delta\Omega_2 \Delta S \times$$

$$\times \int_0^{\Delta t} I_d dt \cdot \rho_t D_t \cdot (1 - \tau) \cdot \varepsilon(\Omega_1, E_1) \varepsilon(\Omega_2, E_2)$$

Rate of elastic p-d coincidences:

$$N_{\text{el}}(\Omega_1^{\text{el}}) = \frac{d\sigma}{d\Omega_1^{\text{el}}}(\Omega_1^{\text{el}}) \cdot \Delta\Omega_1^{\text{el}} \cdot \int_0^{\Delta t} I_d dt \cdot \rho_t D_t \cdot (1 - \tau) \cdot \varepsilon(\Omega_1^{\text{el}}, E_1^{\text{el}}) \varepsilon(\Omega_2^{\text{el}}, E_2^{\text{el}})$$

Normalized breakup cross section:

$$\frac{d^5\sigma}{d\Omega_1 d\Omega_2 dS}(S, \Omega_1, \Omega_2) = \frac{d\sigma}{d\Omega_1^{\text{el}}}(\Omega_1^{\text{el}}) \cdot \frac{N_{\text{br}}(S, \Omega_1, \Omega_2)}{N_{\text{el}}(\Omega_1^{\text{el}})} \times$$

$$\times \frac{\Delta\Omega_1^{\text{el}}}{\Delta\Omega_1 \Delta\Omega_2 \Delta S} \cdot \frac{\varepsilon(\Omega_1^{\text{el}}, E_1^{\text{el}}) \varepsilon(\Omega_2^{\text{el}}, E_2^{\text{el}})}{\varepsilon(\Omega_1, E_1) \varepsilon(\Omega_2, E_2)}$$

$^1\text{H}(\vec{d}, pp)n$ Measurement at 130 MeV

Cross Section Results – Example

Faddeev calculations

Realistic NN potentials
CD Bonn, NijmI, NijmII, Av18

3NF models: TM99, UIX

Coupled channel pot.

CD Bonn (mod) + Δ

EFT/ChPT potentials

NNLO – 2N only

NNLO – 2N + 3N

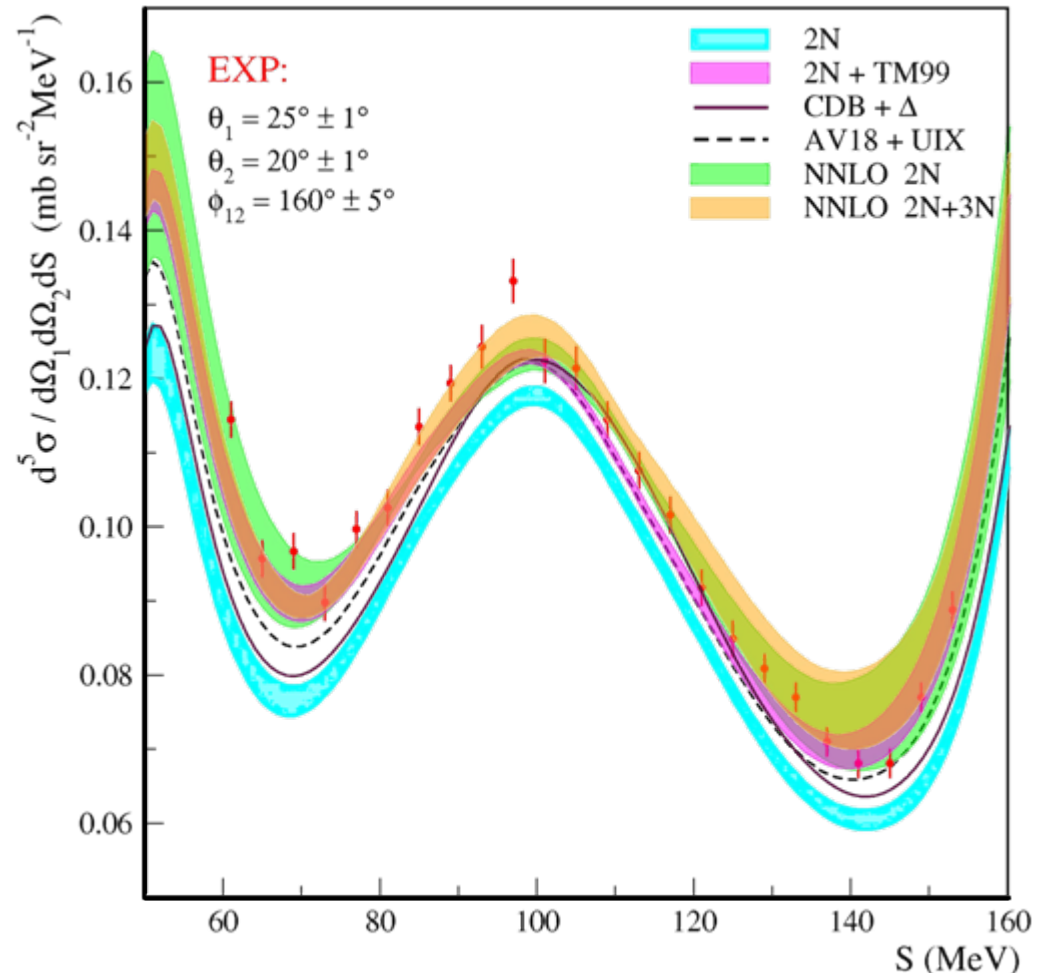

${}^1\text{H}(\vec{d}, pp)n$ Measurement at 130 MeV

Cross Section Results – Summary

- ✓ Nearly 1800 cross section data points
 - $\theta_1, \theta_2 = 15^\circ - 30^\circ$; grid 5° ; $\Delta\theta = \pm 1^\circ$
 - an additional set for $\theta_1, \theta_2 = 13^\circ$
 - $\varphi_{12} = 40^\circ - 180^\circ$; grid $10^\circ - 20^\circ$; $\Delta\varphi = \pm 5^\circ$
 - S [MeV] = 40 - 160; grid 4; $\Delta S = \pm 2$
 - Statistical accuracy 1% - 4%
 - Data very clean - accidentals below 2%
 - Systematic errors of 3% - 5%
- ✓ Global comparisons with theory (χ^2 for all points, $\chi^2 = f(\varphi_{12})$, $\chi^2 = f(E_{\text{rel}})$, tests of normalization)

$^1\text{H}(\vec{d}, pp)n$ Measurement at 130 MeV

Cross Section Results – Exploring Phase Space

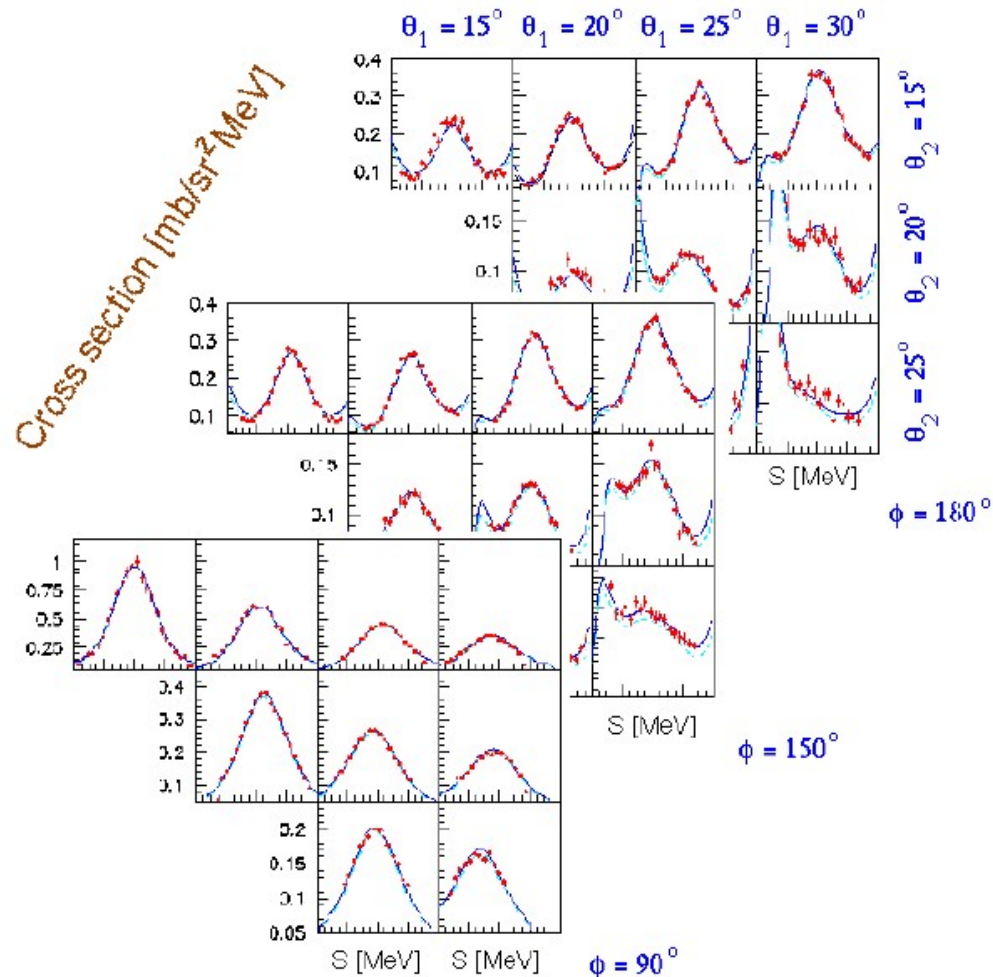

Breakup cross section is a function on 4-dim phase space.

With rich data one might (and should !) explore it by means of projections.

$^1\text{H}(\vec{d}, pp)n$ Measurement at 130 MeV

Cross Section Results – E_{rel} Dependence & 3NF's

Including 3NF
increases discrepancies at low E_{rel} ,
reducing them at
higher E_{rel} values

In general:

Including 3NF's reduces
global χ^2 by about 30%

[Phys. Rev. C 72 (2005) 044006]

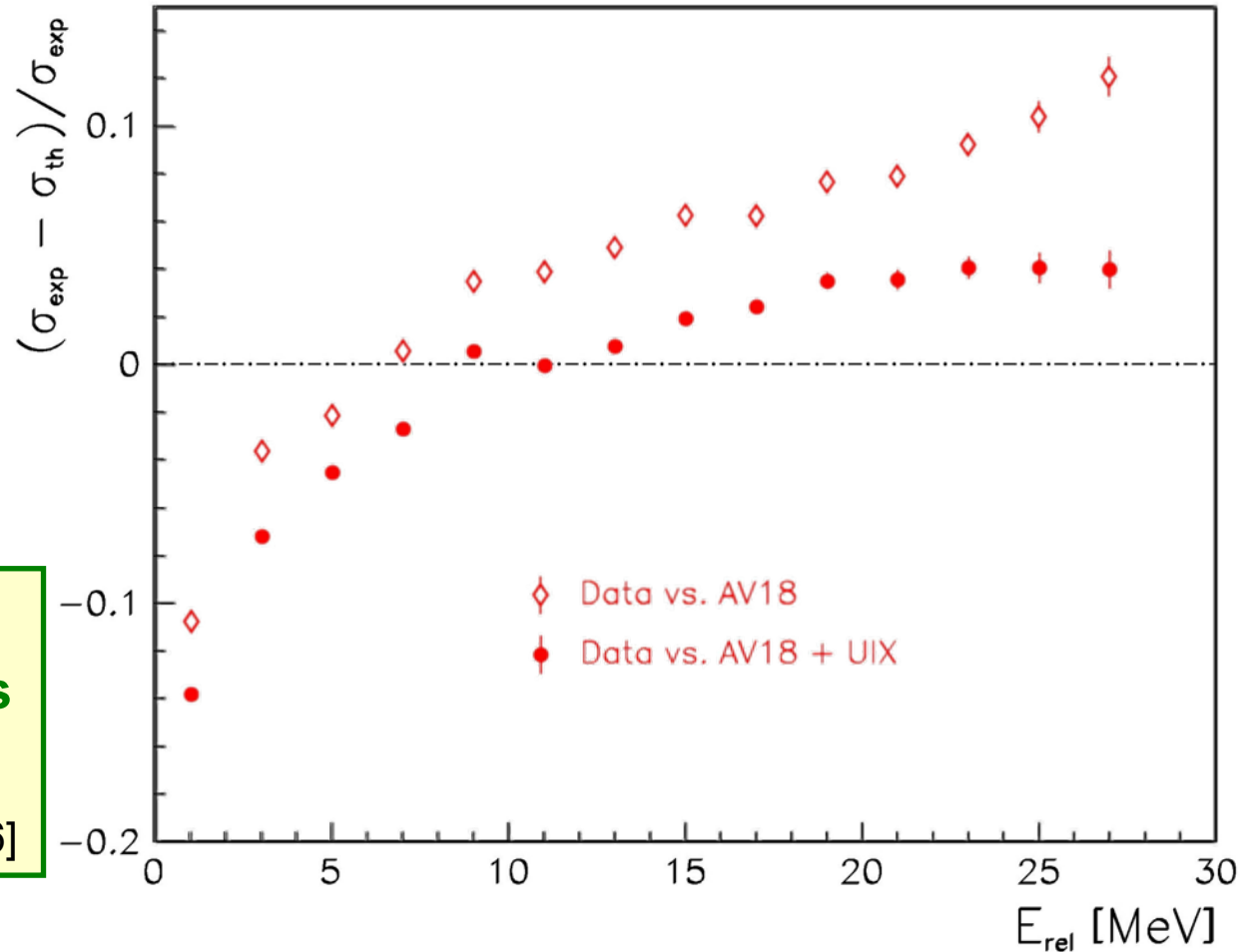

$^1\text{H}(\vec{d}, pp)n$ Measurement at 130 MeV

Cross Section Results – Discrepancies

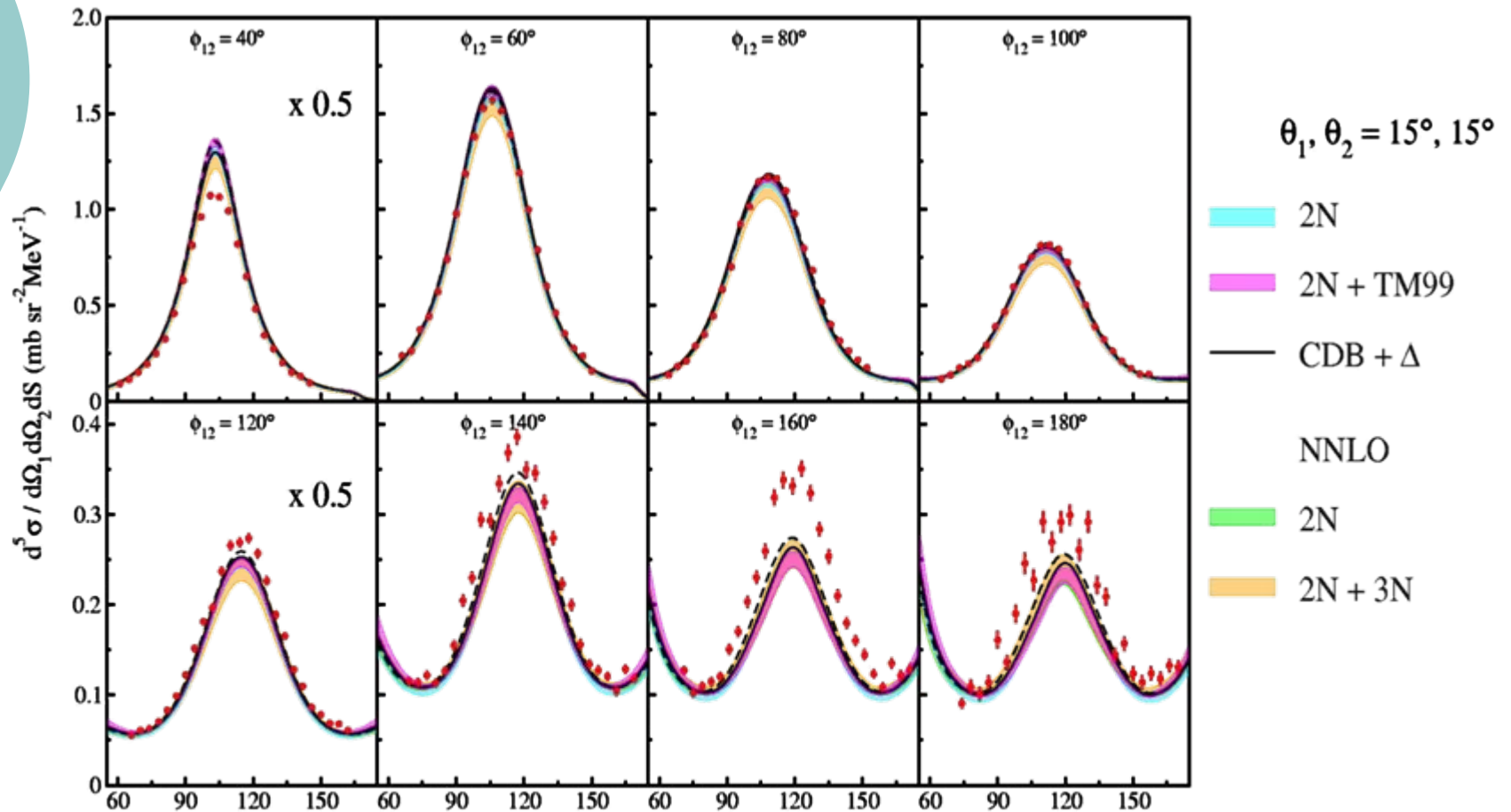

$^1\text{H}(\vec{d}, pp)n$ Measurement at 130 MeV

Cross Section Results – Discrepancies Cured

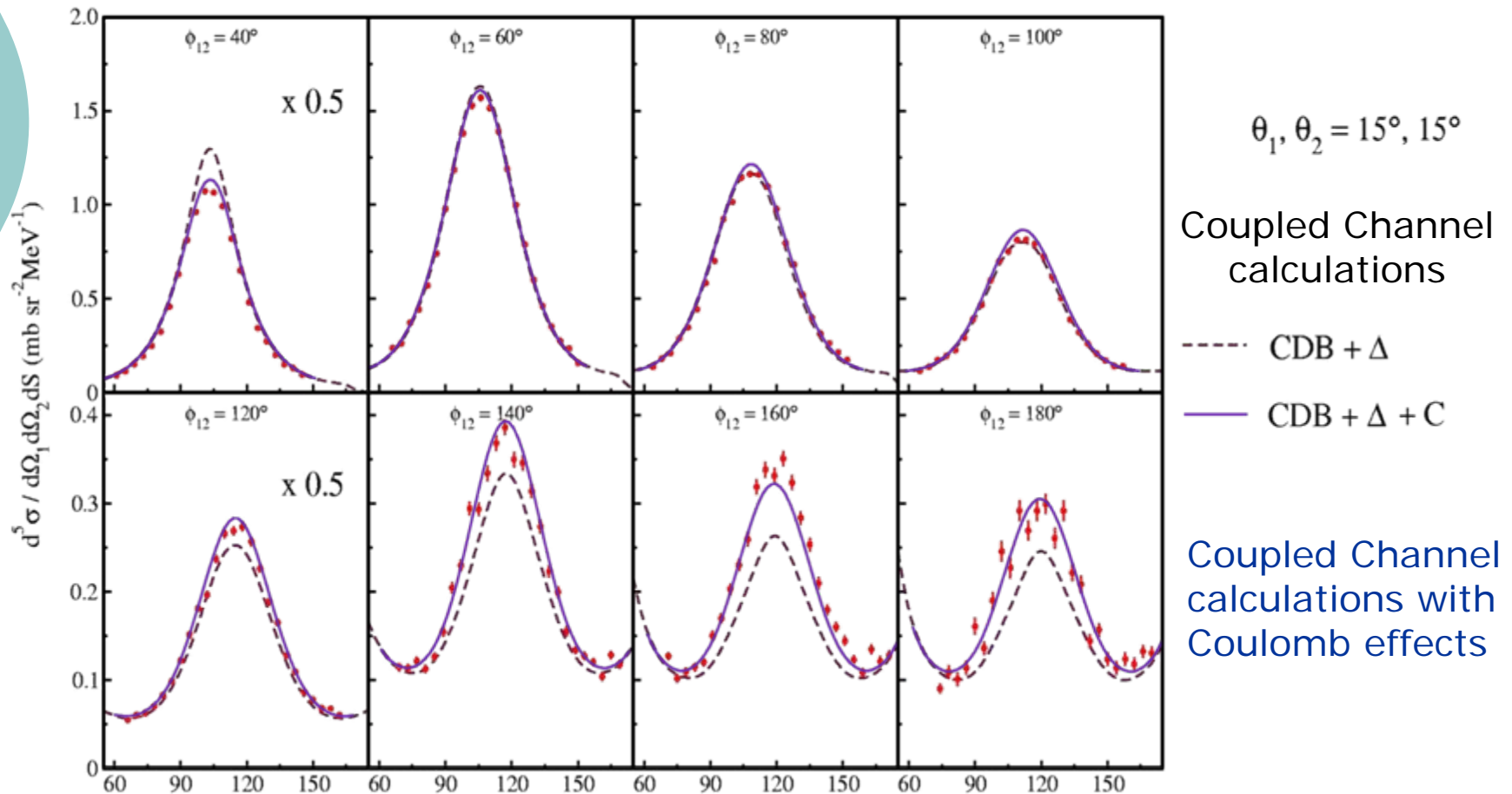

Predictions with Coulomb reproduce data much better !

$^1\text{H}(\vec{d}, pp)n$ Measurement at 130 MeV

Cross Section Results – E_{rel} Dep. & Coulomb

Clear signature of Coulomb effects at small relative energy values !

[Phys. Lett. B 641 (2006) 23]

What about 3NF effects ?

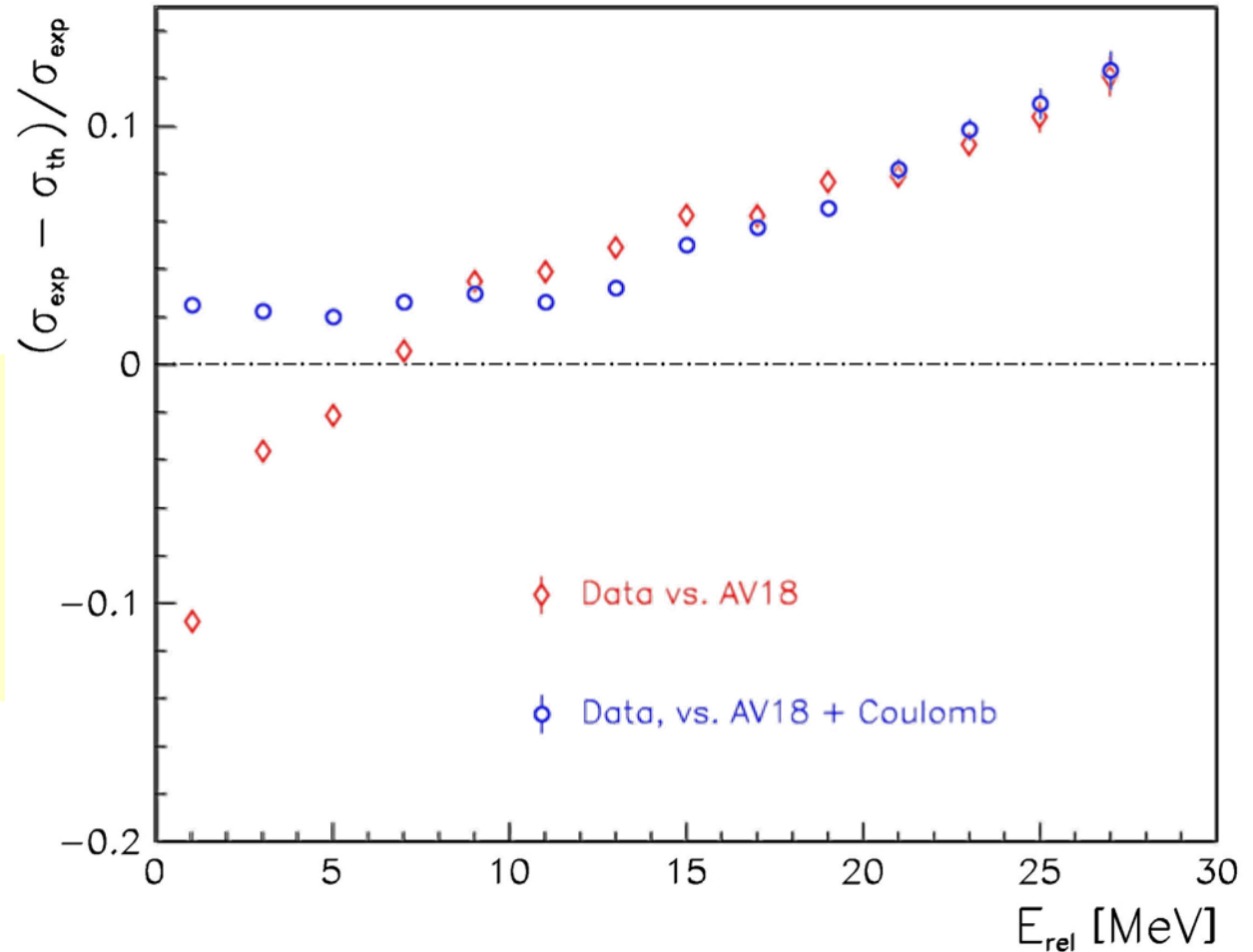

$^1\text{H}(\vec{d}, pp)n$ Measurement at 130 MeV

Cross Section Results – 3NF & Coulomb Effects

In the realistic potentials approach and within the ChPT **only** $n+D$ system was considered

Now Coulomb effects and phenomenological 3NF can be calculated simultaneously !

A. Deltuva, Phys. Rev. C 80 (2009) 064002



Quantitative comparison of the role of both contributions

$^1\text{H}(\vec{d},pp)n$ Measurement at 130 MeV

Cross Section Results – 3NF & Coulomb Effects

Including Coulomb force effects improves the agreement with the data at low E_{rel} values

The best agreement is reached when both, the Coulomb force and the 3NF are taken into account !

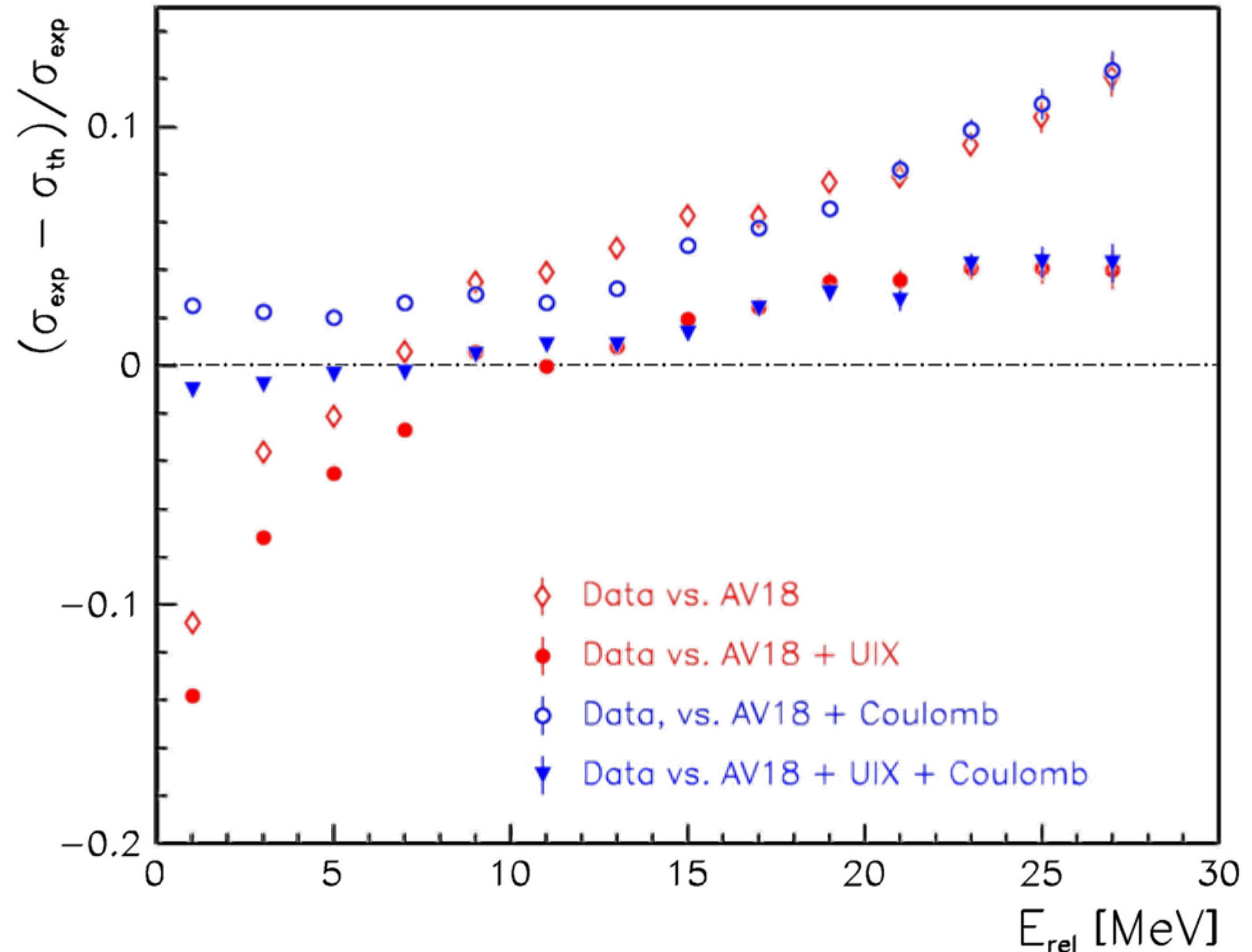

$^1\text{H}(\vec{d}, pp)n$ Measurement at 130 MeV

Cross Section Results – Coulomb Effects

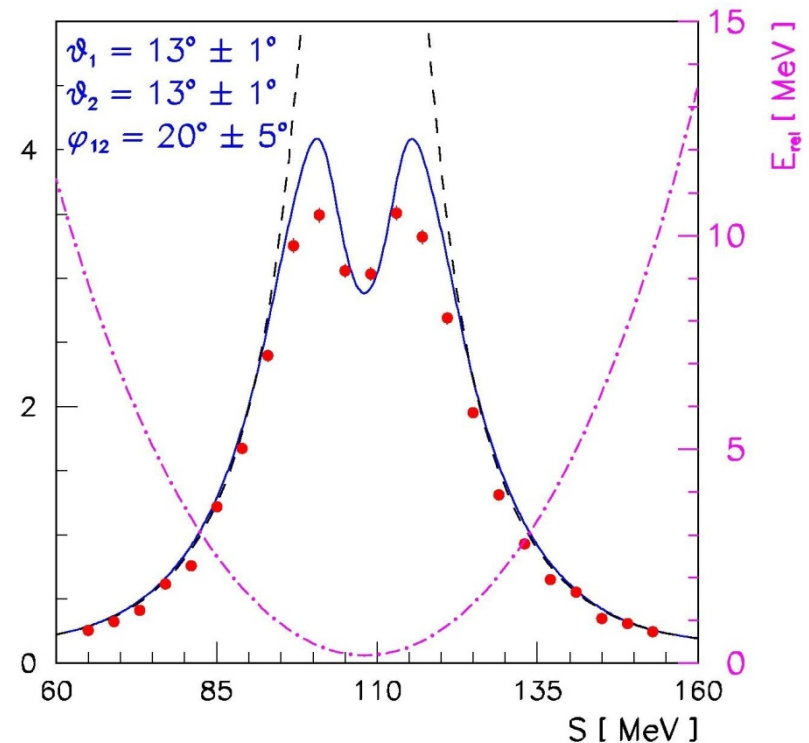
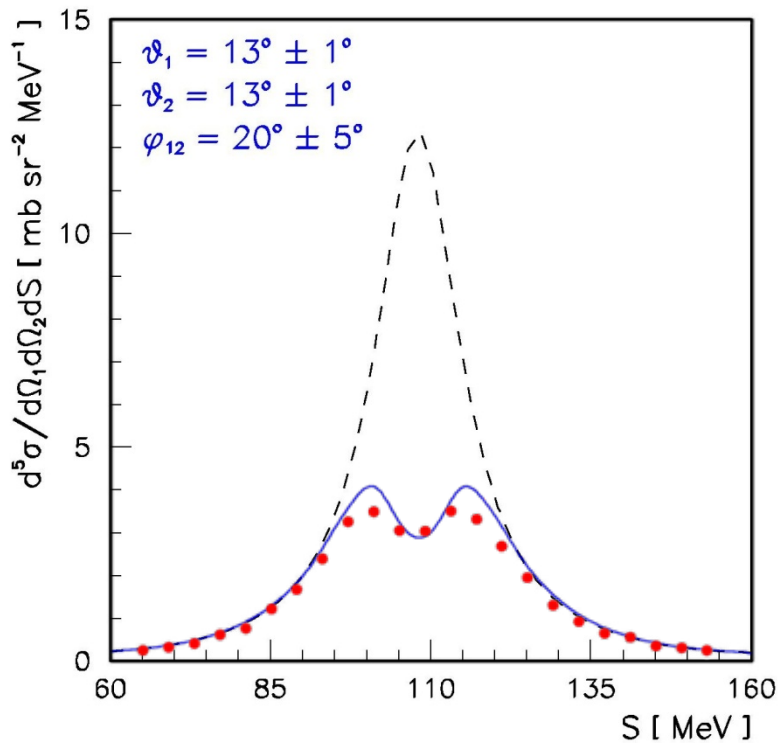

Acceptance limit
of KVI experiment

$^1\text{H}(\vec{d}, pp)n$ Measurement at 130 MeV Germanium Wall Exp. @ COSY / BigKarl



$^1\text{H}(\vec{d}, pp)n$ Measurement at 130 MeV Germanium Wall Exp. @ COSY / BigKarl

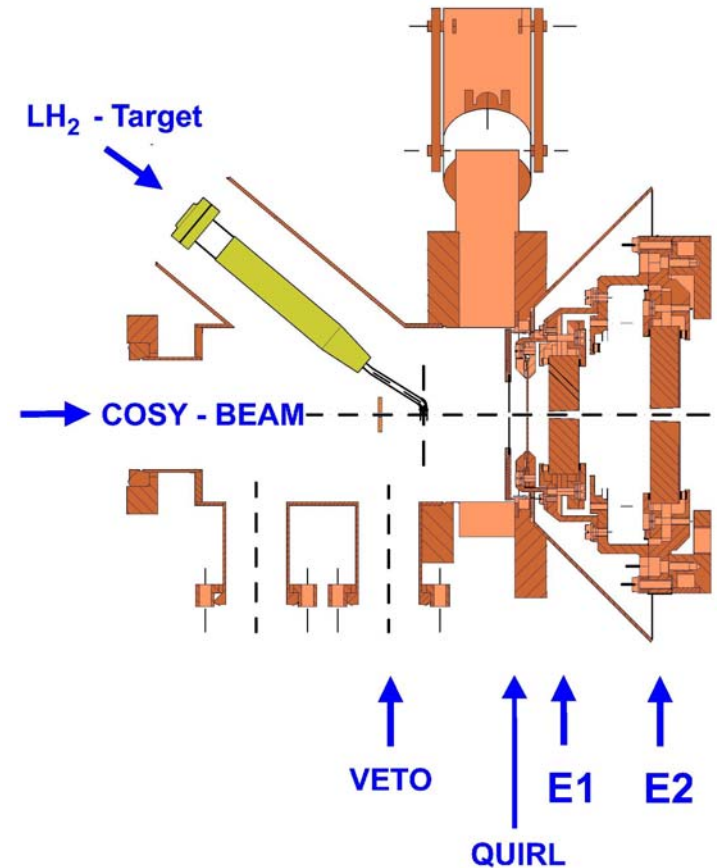
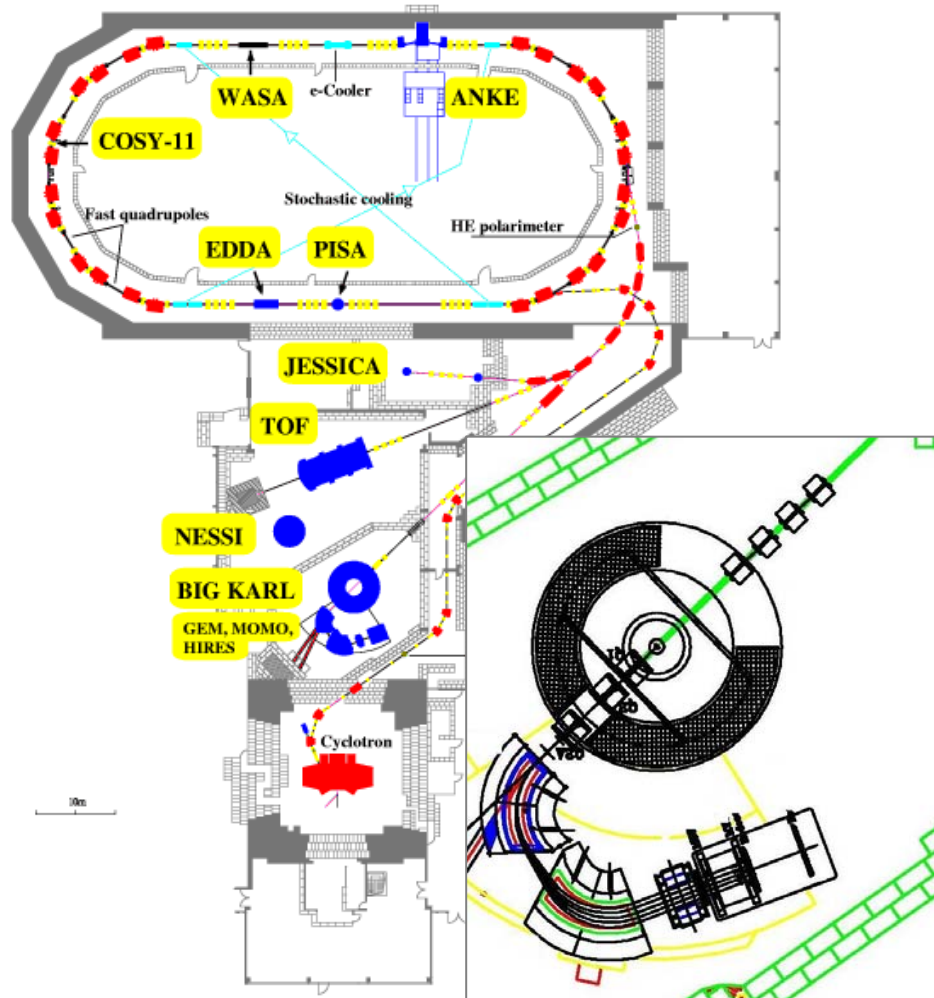

$^1\text{H}(\vec{d}, pp)n$ Measurement at 130 MeV Germanium Wall Exp. @ COSY / BigKarl

Very forward-angle region
 $\theta = 5^\circ - 15^\circ$

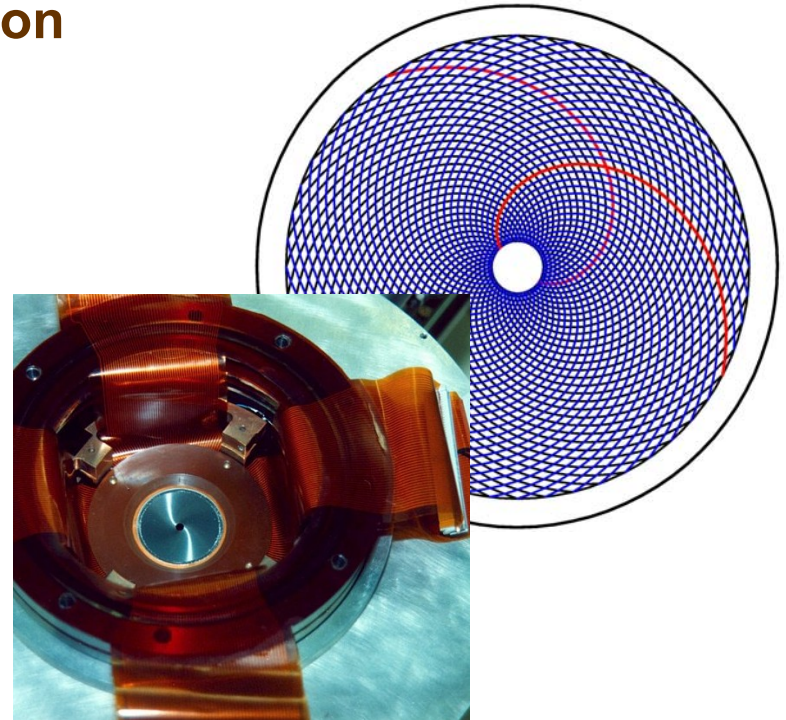
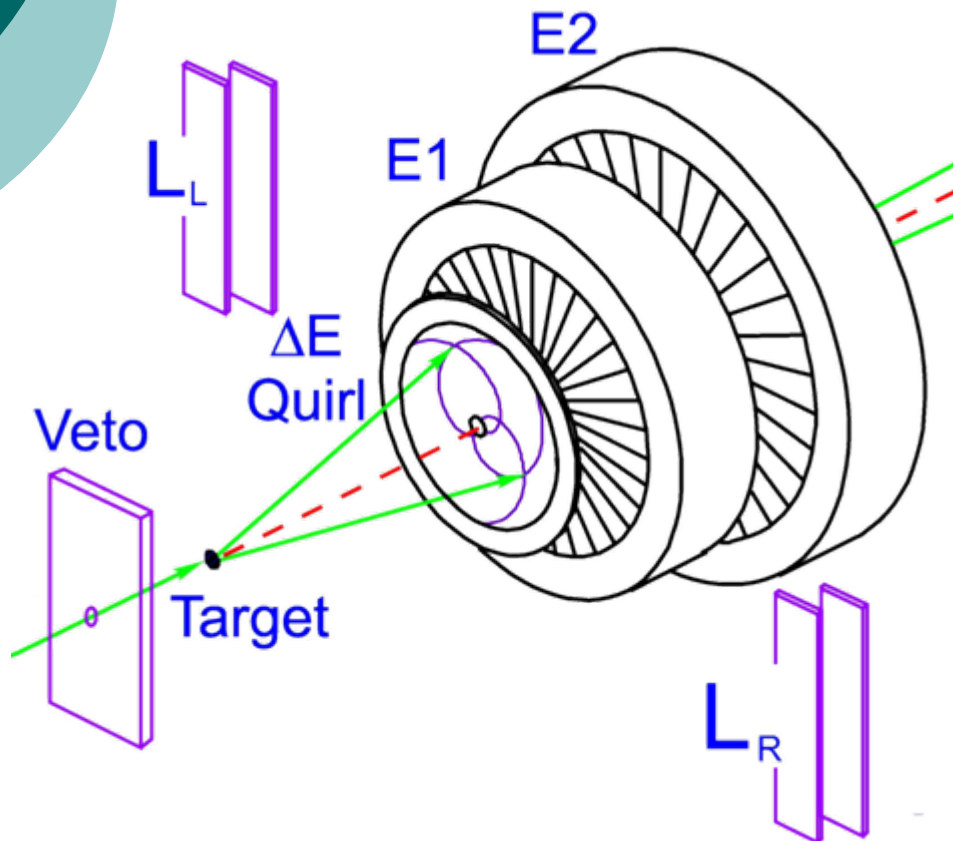

Quirl

2•200 spiral segments
pixel 0.011-0.101 mm²

$^1\text{H}(\vec{d}, pp)n$ Measurement at 130 MeV Germanium Wall Exp. @ COSY / BigKarl

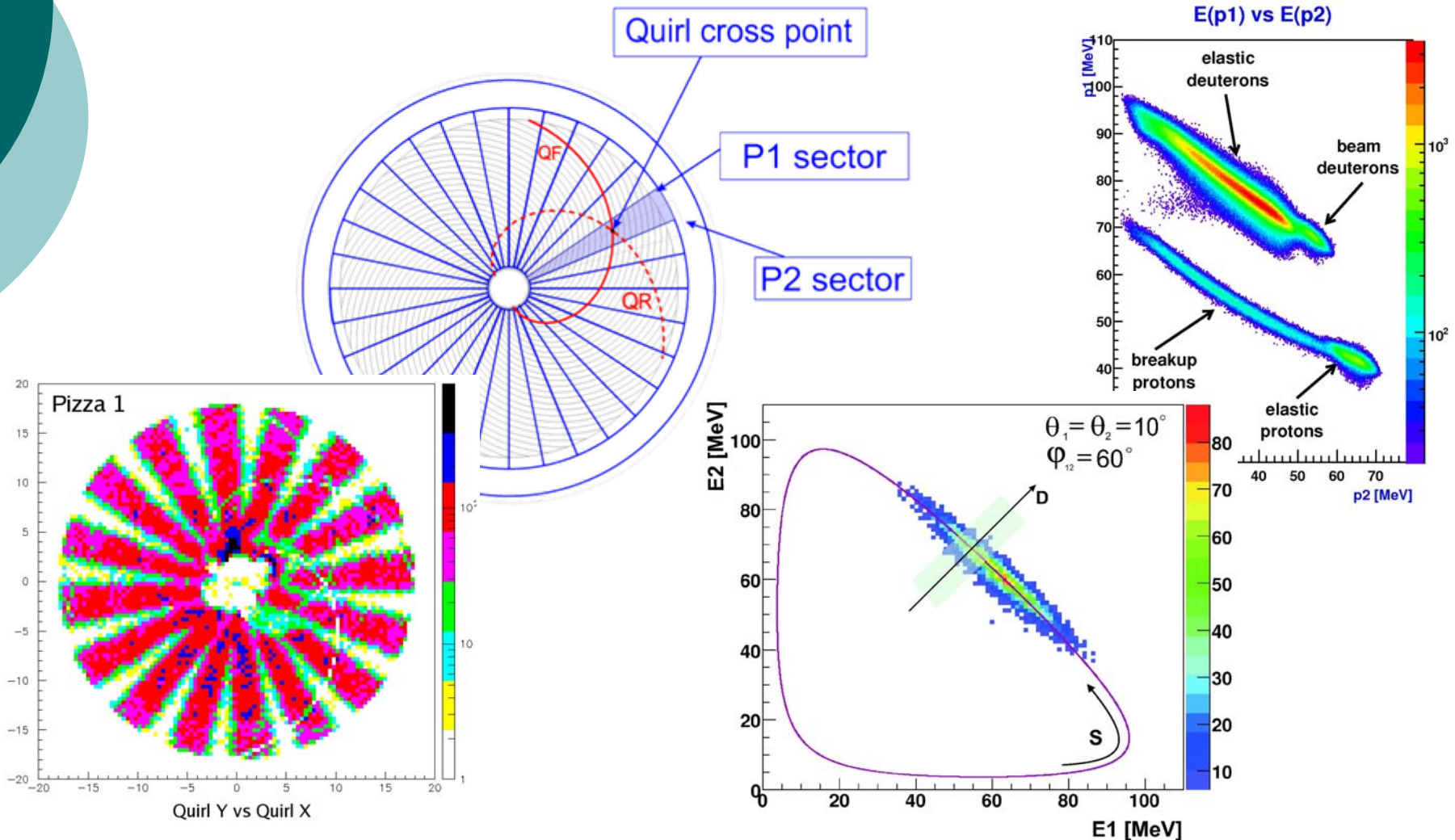

$^1\text{H}(\vec{d}, pp)n$ Measurement at 130 MeV

FZJ Cross Section Results – Summary

✓ Nearly 2700 cross section data points

- $\theta_1, \theta_2 = 5^\circ - 13^\circ$; grid 2° ; $\Delta\theta = \pm 1^\circ$
- $\varphi_{12} = 20^\circ - 180^\circ$; grid 20° ; $\Delta\varphi = \pm 5^\circ$
- S [MeV] = 40 - 180; grid 4; $\Delta S = \pm 4$

- Statistical accuracy 2% - 5%
- Data very clean - accidentals below 2%
- Systematic errors of 5% - 10%

x Certain configs. still with large systematic uncert.

- ✓ Global comparisons with theory: χ^2 /d.o.f.
 $\chi^2 = f(\varphi_{12})$, $\chi^2 = f(\theta_1, \theta_2)$, $\chi^2 = f(E_{\text{rel}})$

$^1\text{H}(\vec{d},pp)n$ Measurement at 130 MeV

Cross Section Results – Examples

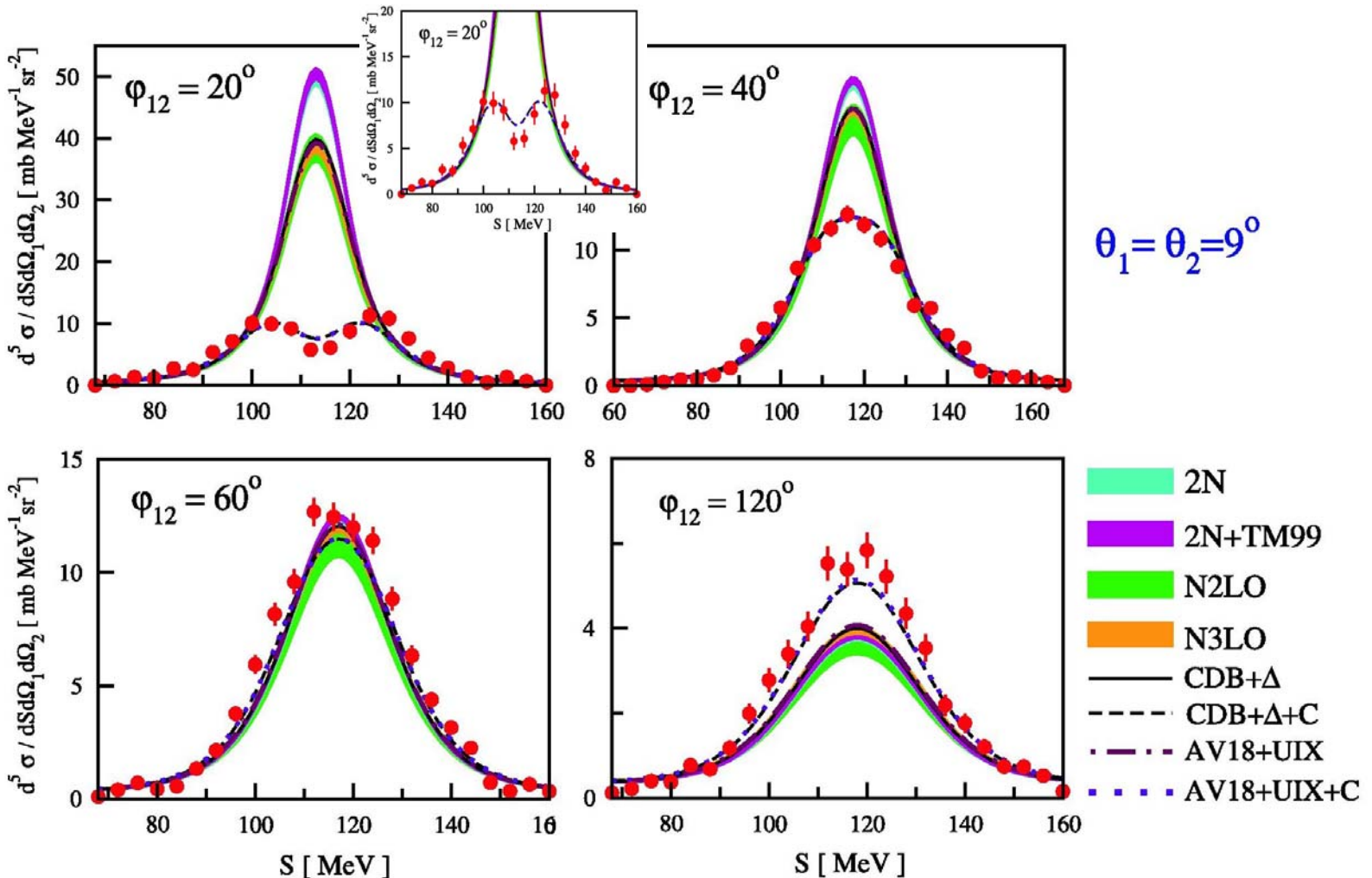

$^1\text{H}(\vec{d}, pp)n$ Measurement at 130 MeV

Cross Section Results – Averaging

Averaging important !

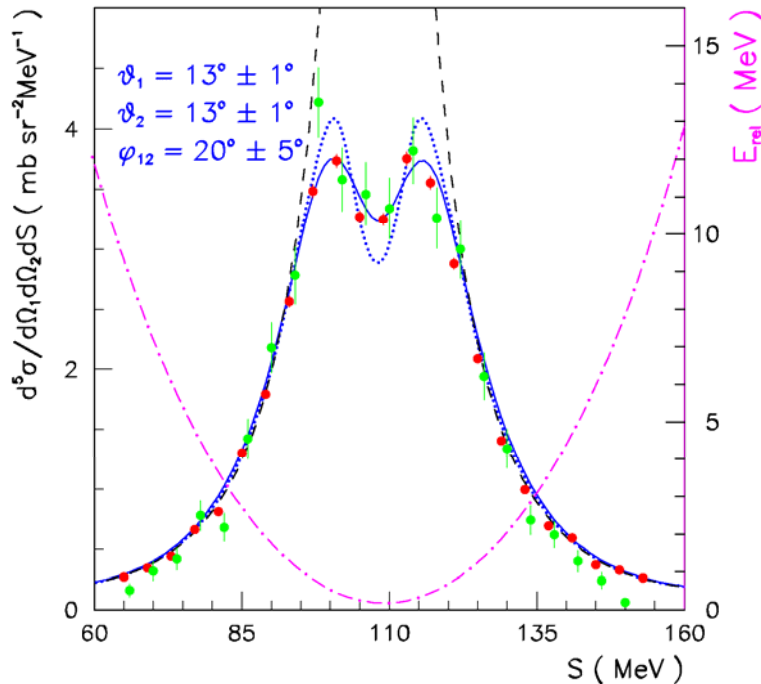

Comparison
 ● KVI ; ● FZJ

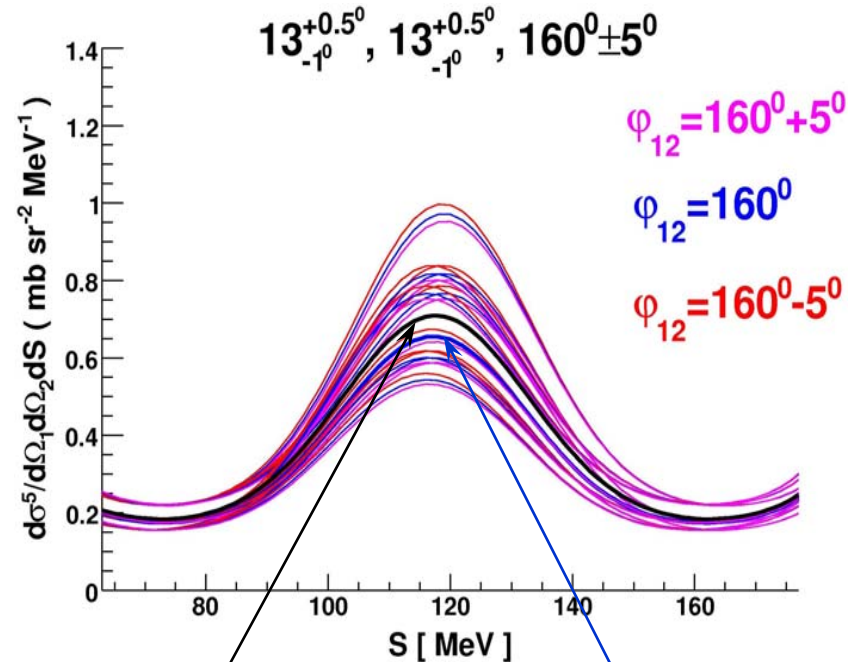

Central
geometry

Averaged

$^2\text{H}(\vec{p}, pp)n$ Measurements

Cross Section Results – Relativistic Effects

CD Bonn potential

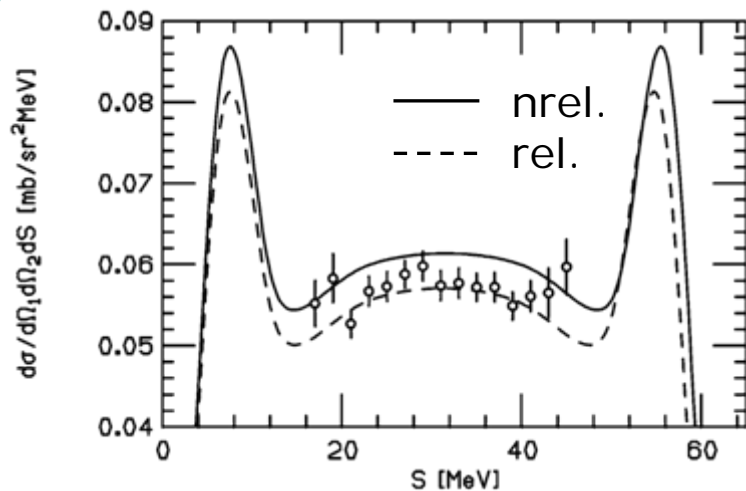

65 MeV (PSI)

$\theta_1 = \theta_2 = 54^\circ, \phi_{12} = 120^\circ$

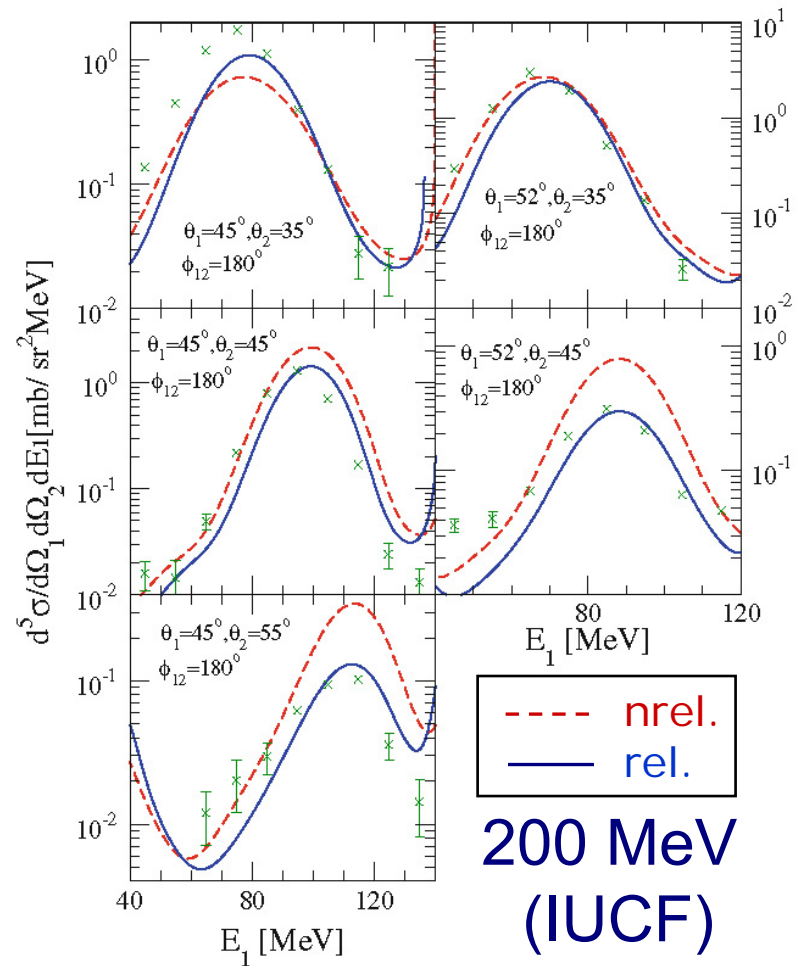

200 MeV
(IUCF)

$^1\text{H}(\vec{d}, pp)n$ Measurements at 130 MeV

Summary

- Systematic, precise sets of **cross sections** (and analyzing powers \rightarrow E.S.) obtained at $E_d = 130$ MeV
➔ basis for comparing different approaches which predict the 3N system observables
- **Showed significant 3NF effects for cross sections !**
- Found large influence of the Coulomb force on c.s.
- Relativistic effects to be studied in detail
- Interplay of different ingredients of 3N system dynamics - inspection started !
- Discrepancies - hint of missing pieces in dynamic models
- Follow further precise and rich data sets, as well as theoretical advances !

Breakup Measurements

Outlook and Wishes (3N and 4N systems)

- Prospects for further results:
 - Evaluating the data accumulated in several experiments at KVI
 - More measurements:
 - Japan: RIKEN, RCNP, RIBF, ...
 - Projects for PAX@COSY & WASA@COSY
 - INP Cracow



3N System Dynamics - St. Kistryn IF UJ

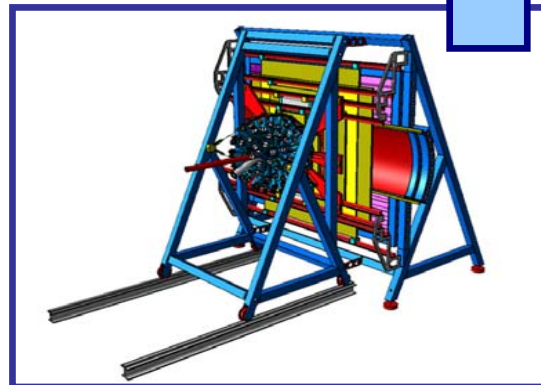

SLCJ Workshop; March 5, 2013

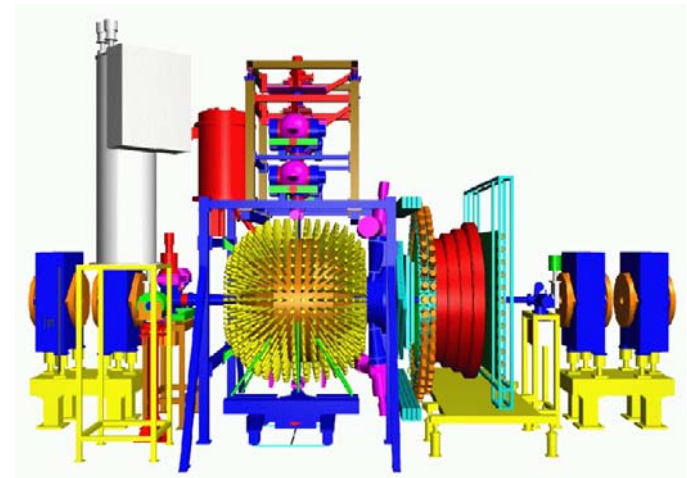

Personal, surely incomplete view

Few-Body Research at IFJ PAN Kraków Cyclotron Center Bronowice

Cyclotron:

- Energy 230 MeV (down to 70 MeV)
- $\Delta E/E < 0.7\%$
- Beam intensity 500 nA – 0.1 nA

experimental area

proton therapy

PROTEUS C-235

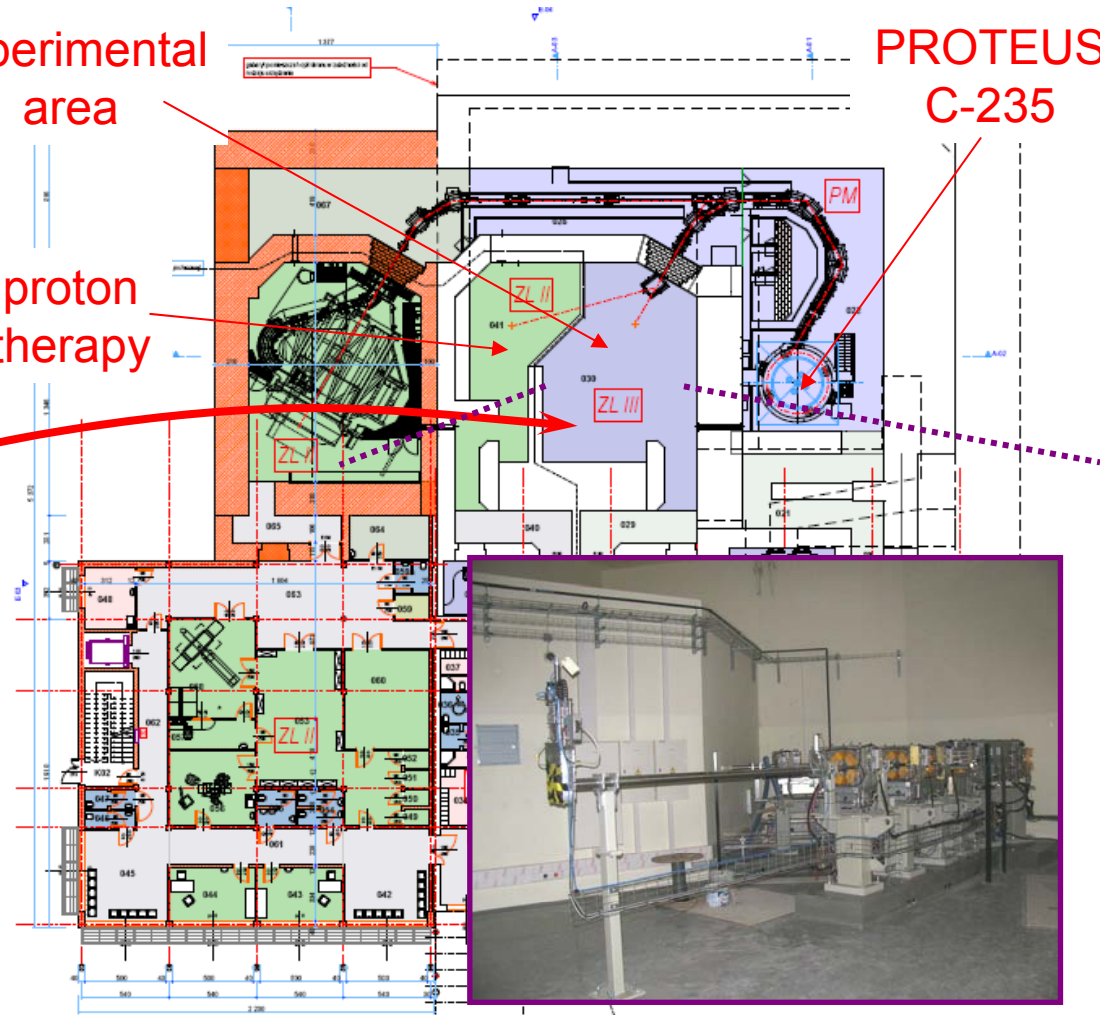
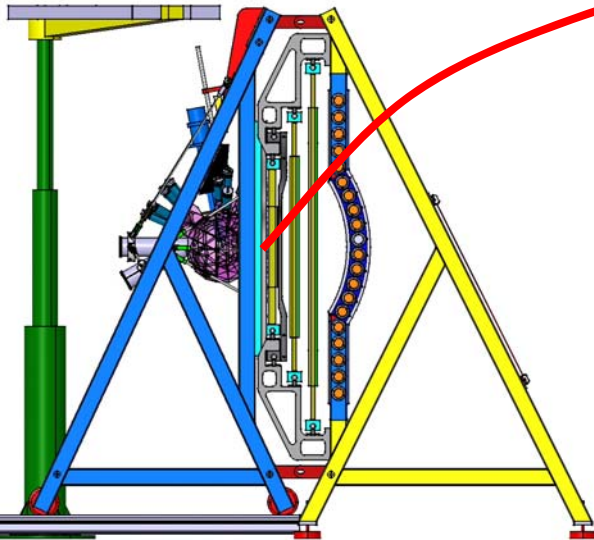

Breakup Measurements

Outlook and Wishes (3N and 4N systems)

- Prospects for further results:
 - Evaluating the data accumulated in several experiments at KVI
 - More measurements:
 - Japan: RIKEN, RCNP, RIBF, ...
 - Projects for PAX@COSY & WASA@COSY
 - BINA@INP Cracow
- Awaited theoretical achievements:
 - 3NF at N³LO (close ahead...)
 - ChPT with Δ (work in progress...)
 - ✓ Realistic potentials with Coulomb
 - Rigorous calculations for 4N system (dreamed for !)

Personal, surely incomplete view

22-nd EUROPEAN CONFERENCE ON FEW-BODY PROBLEMS IN PHYSICS

CRACOW, POLAND

9 - 13 September 2013



**Thank You
for attention**

Contact addresses:

stanislaw.kistryn@uj.edu.pl

jacek.golak@uj.edu.pl